



**Graded sum formula for  $\tilde{A}_1$ -Soergel calculus and the nil-blob algebra**

Marcelo Eduardo Hernández Caro

A thesis submitted in partial fulfillment of the requirements  
for the degree of Doctor of Mathematics

Institute of Mathematics  
University of Talca

March 2024

## Agradecimientos

*En primer lugar quiero agradecer a mi profesor tutor Steen Ryom-Hansen por todo su apoyo durante esta etapa de mi vida, tanto en magister como en doctorado. Siempre estaré agradecido por toda la paciencia que tuvo conmigo cuando las cosas no funcionaban del todo bien y por todos sus consejos cuando notaba que yo estaba decidiendo mal. Muchas gracias por confiar en mí.*

*Por otra parte, quiero manifestar mis agradecimientos a Silvia y Marcelo, mis padres, por siempre apoyarme en mis sueños, por no cortarme las alas al momento de decidir cambiar de rumbo y estudiar matemáticas. También a mi hermana Javiera y mi abuela Flor, por ese cariño que siempre me entregan. Además, me gustaría agradecerles a don Vladimir, señora Ana y Matías, por darme ánimos y confiar en mí. A su vez, quiero agradecerle a mi abuela Lupa, por todo lo que me entregó en vida y lo que aún me entrega cuando la recuerdo con ese amor que jamás desaparecerá. Un beso al cielo.*

*Al mismo tiempo, agradezco a cada uno de mis amigos que siempre estuvieron y aún están ahí, los que siempre me instaron a seguir cuando yo dudaba de todo esto. En especial me gustaría agradecer a Paul Meneses y Cristian González por siempre ayudarme cuando estuve mal y nunca pedir nada a cambio, por las risas, los buenos momentos, y los otros también. Por otra parte, a Lino Barrera y David Villota, por la amistad de infancia, por acompañarme en todas las etapas de mi vida y siempre darme ánimos para lograr mis sueños de niño. Y obviamente, a Carlos Muñoz, mi amigo y hermano, el que siempre está ahí cuidándome, el que nunca falla. Gracias por todas las incontables veces que me has ayudado.*

*Finalmente, le agradezco infinitamente a mi pareja Gabriela Valenzuela, por su incondicionalidad. Gracias por acompañarme en toda esta aventura, por ayudarme a cumplir mis sueños y por la hermosa familia que hemos formado junto a Salvador y Violeta. Doy gracias a la vida por hacerme coincidir contigo, por hacerme coincidir con todo tu amor.*

*Esta tesis fue financiada parcialmente por ANID-PCHA/Doctorado Nacional/2019-21190827.*



## Introduction

Cellular algebras were introduced by Graham and Lehrer in 1994 in the paper [15] as a framework for studying the non-semisimple representation theory of many finite dimensional algebras. The motivating examples for cellular algebras were the Iwahori-Hecke algebras of type  $A_n$  and Temperley-Lieb algebras, but it has since been realized that many other finite dimensional algebras fit into this framework. For a cellular algebra one has a family of cell modules  $\{\Delta(\lambda)\}$ , endowed with bilinear forms  $\langle \cdot, \cdot \rangle_\lambda$ , that together control the representation theory of the algebra in question. Unfortunately, the concrete analysis of these bilinear forms is in general difficult, but in this thesis we give a non-trivial cellular algebra over  $\mathbb{C}$  for which the bilinear forms  $\langle \cdot, \cdot \rangle_\lambda$  can in fact be diagonalized over an integral form of the algebra, thus solving all relevant questions concerning them, and therefore, by cellular algebra theory, concerning the representation theory of the algebra itself.

Our cellular algebra has two origins. Firstly it arises in the diagrammatic Soergel calculus of the Coxeter system  $(W, S)$  of type  $\tilde{A}_1$  as the endomorphism algebra  $\tilde{A}_w^{\mathbb{C}} := \text{End}(w)$  of  $w := stst\cdots$  of length  $n$ , where  $S = \{s, t\}$ . An approach to Soergel calculus of universal Coxeter groups, in particular of type  $\tilde{A}_1$ , has been developed recently by Elias and Libedinsky in [10], see also [8]. For type  $\tilde{A}_1$  this approach involves the two-colour Temperley-Lieb algebra but unfortunately the two-colour Temperley-Lieb algebra only captures the degree zero part of  $\tilde{A}_w^{\mathbb{C}}$ , whereas our interests lie in the full grading on  $\tilde{A}_w^{\mathbb{C}}$ .

The second origin of our cellular algebra is as a certain idempotent truncation  $\mathbb{N}\mathbb{B}_{n-1}$  of Martin and Saleur's blob-algebra from [35]. In [33] the algebras  $\tilde{A}_w^{\mathbb{C}}$  and  $\mathbb{N}\mathbb{B}_{n-1}$  were studied extensively and in particular presentations in terms of generators and relations were found for each of them. Using this it was shown that there is an isomorphism  $A_w^{\mathbb{C}} \cong \mathbb{N}\mathbb{B}_{n-1}$  where  $A_w^{\mathbb{C}}$  is a natural diagrammatically defined subalgebra of  $\tilde{A}_w^{\mathbb{C}}$ , whose dimension is half the dimension of  $\tilde{A}_w^{\mathbb{C}}$ . On the other hand, we show in this thesis that the representation theory of  $\tilde{A}_w^{\mathbb{C}}$  can be completely recovered from the representation theory of  $A_w^{\mathbb{C}}$ .

Similarly to the original blob-algebra, the diagrammatics for  $\mathbb{N}\mathbb{B}_{n-1}$  is given by blobbed (marked) Temperley-Lieb diagrams, although the rule for multiplying diagrams is different. Following [33], we call  $\mathbb{N}\mathbb{B}_{n-1}$  the nil-blob algebra, but in fact  $\mathbb{N}\mathbb{B}_{n-1}$  has also appeared in the literature under the name the *dotted Temperley-Lieb algebra*, see [42].

An important feature of  $\tilde{A}_w^{\mathbb{C}}$  and  $\mathbb{N}\mathbb{B}_{n-1}$ , and in fact of all cellular algebras appearing in this thesis, is the fact that they are  $\mathbb{Z}$ -graded algebras, with explicitly given degree functions defined in terms of the diagrams. They are  $\mathbb{Z}$ -graded cellular in the sense of Hu and Mathas, see [20].

Our main interest lies in the representation theory of  $A_w$ . To study this, we construct integral forms  $A_w$  and  $\mathbb{B}_{n-1}^{x,y}$  for  $A_w^{\mathbb{C}}$  and  $\mathbb{N}\mathbb{B}_{n-1}$  over the two-parameter polynomial algebra  $R := \mathbb{C}[x, y]$  and a lift of the isomorphism  $A_w^{\mathbb{C}} \cong \mathbb{N}\mathbb{B}_{n-1}$  to  $A_w \cong \mathbb{B}_{n-1}^{x,y}$ . The integral form  $A_w$  is in fact already implicit in the setup for Soergel calculus, using the dual geometric realization of the Coxeter group  $W$  of type  $\tilde{A}_1$ . Under this realization, the parameters  $x$  and  $y$  correspond to the two simple roots for  $W$ . The integral form for  $\mathbb{N}\mathbb{B}_{n-1}$  is also a well-known object, since it is simply the two-parameter blob-algebra  $\mathbb{B}_{n-1}^{x,y}$  with blob-parameter  $x$  and marked loop parameter  $y$ . Thus the novelty of our result lies primarily in the isomorphism between these integral forms, which on the other hand has the quite surprising consequence of rendering a Coxeter group theoretical meaning to the two blob algebra parameters for  $\mathbb{B}_{n-1}^{x,y}$ , since they become nothing but the simple roots for  $W$ .

So, via the above isomorphism, the representation theory of  $A_w$  is equivalent to the representation theory of  $\mathbb{B}_{n-1}^{x,y}$ . For several reasons the representation theory of  $\mathbb{B}_{n-1}^{x,y}$  is more convenient to handle. Both algebras are cellular algebras with diagrammatically defined cellular bases, but the straightening rules for expanding the product of two cellular basis elements in terms of the cellular basis are easier in the  $\mathbb{B}_{n-1}^{x,y}$  setting. Additionally, there is a natural Temperley-Lieb subalgebra  $\mathbb{T}\mathbb{L}_{n-1}$  of  $\mathbb{B}_{n-1}^{x,y}$  whose associated restriction functor  $\text{Res}$  is very useful for our

purposes, because  $\text{Res}$  satisfies some properties which imply a diagonalization process for the bilinear form  $\langle \cdot, \cdot \rangle$  of a cell module in  $\mathbb{B}_{n-1}^{x,y}$ , and therefore, for the bilinear form of a cell module in  $A_w$ .

The values of the diagonalized matrix associated to the bilinear form are obtained using the Jones-Wenzl idempotent elements for  $\mathbb{T}\mathbb{L}_n$ . The determination of these coefficients constitutes the main calculatory ingredient of our thesis. Although one may possibly not have expected Coxeter theory to appear in this calculation, the result turns out to be a nice product of positive roots for  $W$ .

This work is partially motivated by the paper [44] in which a diagonalization of the bilinear form for the cell module for  $\tilde{A}_w$  is obtained, in fact the results of [44] are valid for a general Coxeter system. Unfortunately, as was already mentioned in [44], the diagonalization process in that paper does not work over  $R$  itself, but only over the fraction field  $Q$  of  $R$ , since it relies on certain Jucys-Murphy elements for  $A_w$  that are of degree 2, and not 0. As a consequence the  $\mathbb{Z}$ -graded structure on the cell module for  $\tilde{A}_w$  breaks down under the diagonalization process in [44]. The diagonalization process of the present thesis, however, which is based on the Jones-Wenzl idempotents that are of degree 0, resolves this problem at least for type  $\tilde{A}_1$ .

After the diagonalization process, we use the results to set up a version of the Jantzen filtration formalism for the graded cell modules of  $\tilde{A}_w$ , using its bilinear form, and later, to set up a graded sum formula that holds at *enriched Grothendieck* group level.

The layout of the thesis is divided in two chapters. Chapter 1 recalls preliminary concepts. In section 1 we recall the original definition of Jantzen filtration over a principal ideal domain and the sum formula. In section 2 we recall the concept of cellular algebra, cell module and its bilinear form, adding as example  $\mathbb{T}\mathbb{L}_n$ . In section 3 we define the Jones-Wenzl idempotent elements  $\mathbf{JW}_n$  in  $\mathbb{T}\mathbb{L}_n$  and show several properties that  $\mathbf{JW}_n$  holds. In the last section of this chapter we define de Soergel calculus algebra  $\tilde{A}_w$  in our particular context, its *light leaves* basis, and show a non-recursive formula that light leaves hold.

Chapter 2 develops the main content of our work. In section 1 we introduce some notation that shall be used throughout the thesis and recall two additional algebras that play a role throughout: the blob algebra  $\mathbb{B}_n^{x,y}$  and the nil-blob algebra  $\mathbb{N}\mathbb{B}_n$ . We also recall how each of them fits into the cellular algebra language. In section 2 we introduce the subalgebra  $A_w$  of  $\tilde{A}_w$  and show the isomorphism  $\mathbb{B}_{n-1}^{x,y} \cong A_w$  that was mentioned above. We also show how the cellular algebra structure on  $\tilde{A}_w$  induces a cellular structure on  $A_w$  and that there is an isomorphism  $\Delta_{n-1}^{\mathbb{B}}(\lambda) \cong \Delta_w(\nu)$  between the respective cell modules for  $\mathbb{B}_{n-1}^{x,y}$  and  $A_w$ . In section 3 we consider a natural filtration of  $\text{Res}\Delta_n^{\mathbb{B}}(\lambda)$  where  $\text{Res}$  is the restriction functor from  $\mathbb{B}_{n-1}^{x,y}$ -modules to  $\mathbb{T}\mathbb{L}_{n-1}$ -modules. We show that the Jones-Wenzl idempotents  $\mathbf{JW}_k$  for  $\mathbb{T}\mathbb{L}_k$  where  $k \leq n-1$  can be used to construct sections for this filtration and to diagonalize the bilinear form  $\langle \cdot, \cdot \rangle_{n-1, \lambda}^{\mathbb{B}}$  on  $\Delta_{n-1}^{\mathbb{B}}(\lambda)$ . In section 4 we prove the key Theorems 2.4.1 and 2.4.2, that were already mentioned above. They allow us to give concrete expressions for the diagonal elements of the matrix for  $\langle \cdot, \cdot \rangle_{n-1, \lambda}^{\mathbb{B}}$ , which, as already mentioned, turn out to be products of positive roots  $\alpha$  for  $W$ . In section 5 we give a description of the reflections  $s_\alpha$  in  $W$  that correspond to the positive roots of section 4. Finally, in section 6 we use the results of the previous sections to give the graded Jantzen filtration with corresponding graded sum formula.

## Contents

Chapter 1. Preliminaries	7
1. Jantzen filtration over a principal ideal domain	7
2. Cellular algebras	11
3. The Jones-Wenzl elements in Temperley-Lieb algebra	15
4. Soergel Calculus	21
Chapter 2. Graded sum formula for $\tilde{A}_1$ -Soergel calculus and the nil-blob algebra	29
1. Blob algebras	29
2. Isomorphism Theorems	31
3. Restriction of $\Delta_n^{\mathbb{R}}(\lambda)$ to $\mathbb{T}\mathbb{L}_n$	39
4. Determination of $c_i(x, y)$	43
5. Characterization of $c_i(x, y)$ in terms of Bruhat order on $W$	49
6. Graded Jantzen filtrations and sum formulas	50
Bibliography	57



## Preliminaries

### 1. Jantzen filtration over a principal ideal domain

In this section we recall definitions and results about the Jantzen filtration, originally defined in [24] for Verma modules. In this case, we consider a more general and simple version of the Jantzen filtration, following [22] and [23], where the construction of the filtration is defined over a principal ideal domain. In this section, we chose this version of Jantzen filtration because we don't work over Verma modules in this thesis.

Let  $R$  be a principal ideal domain and  $p \in R$  prime. Let  $v_p$  the  $p$ -adic valuation over  $R$ , i.e.,  $v_p(a) = n$  if  $p^n$  divides  $a$  but  $p^{n+1}$  doesn't divide  $a$ . Let  $M$  be a free  $R$ -module of finite rank  $r$  equipped with a non-degenerate symmetric bilinear form  $(\cdot, \cdot)$ . For each non-negative integer  $n$  we define

$$M(n) = \{m \in M : (m, M) \in p^n R\}.$$

From this definition we have the following filtration:

$$M = M(0) \supseteq M(1) \supseteq M(2) \supseteq \dots$$

Now, let be  $\overline{M} = M/pM$ . Then  $\overline{M}$  is a vector space over  $\overline{R} := R/pR$ . So, if we consider  $\overline{M(n)}$  as the image of  $i(M(n))$  under reduction modulo  $p$ , where  $i : M(n) \rightarrow M$  is the natural embedding, then we have the following filtration of  $\overline{R}$ -vector subspaces:

$$\overline{M} = \overline{M(0)} \supseteq \overline{M(1)} \supseteq \overline{M(2)} \supseteq \dots$$

called *Jantzen filtration*.

For the rest of this section we will need the following definitions and results from Module Theory over a principal ideal domain.

LEMMA 1.1.1. *Let  $R$  be a principal ideal domain. Let  $M$  be a free  $R$ -module of finite rank  $r$ , and let  $N$  be a submodule of  $M$ . Then:*

- (1)  *$N$  is free  $R$ -module of rank  $s \leq r$ .*
- (2) *There is a free  $R$ -basis  $\{b_1, b_2, \dots, b_r\}$  for  $M$  and non-zero elements  $\{a_1, a_2, \dots, a_s\}$  such that  $a_1|a_2| \dots |a_s$  and  $\{a_1 b_1, a_2 b_2, \dots, a_s b_s\}$  is a free  $R$ -basis for  $N$ . In other words:*

$$N = \bigoplus_{1 \leq i \leq s} R a_i b_i.$$

DEFINITION 1.1.2. *Let  $R$  be a ring. Let  $M$  be an  $R$ -module. We define the dual module of  $M$  as  $M^* = \text{Hom}_R(M, R)$ .*

LEMMA 1.1.3. *Let  $R$  be a principal ideal domain and  $M$  a free  $R$ -module of finite rank  $r$ . Then,  $M^*$  is also a free  $R$ -module of rank  $r$ .*

LEMMA 1.1.4. *Let  $R$  be a principal ideal domain and  $M$  a free  $R$ -module equipped with a non-degenerate bilinear form  $(\cdot, \cdot)$ . Then the function*

$$\phi : M \rightarrow M^\vee$$

*defined by*

$$\phi(m) = (m, \cdot)$$

*is an isomorphism, where  $M^\vee := \{(m, \cdot) : m \in M\} \subset M^*$ .*

LEMMA 1.1.5. *Let  $R$  a principal ideal domain. Let  $M$  a free  $R$ -module of finite rank  $r$  and  $M^*$  its associated dual module. Let  $(\cdot, \cdot)$  a non-degenerate symmetric bilinear form over  $M$ . Then there are:*

- *A free  $R$ -basis  $\{e_1^*, \dots, e_r^*\}$  for  $M^*$*



- A free  $R$ -basis  $\{f_1, \dots, f_r\}$  for  $M$
- A set of elements  $\{a_1, \dots, a_r\} \subset R$  such that

$$(f_i, \cdot) = a_i e_i^*$$

for each  $i \in \{1, 2, \dots, r\}$ .

*Proof:* Let  $N = M^\vee$ , with  $M^\vee$  from Lemma 1.1.4. Since  $(\cdot, \cdot)$  is non-degenerate, then by Lemma 1.1.4 we have that  $N$  is a free  $R$ -submodule of  $M^*$  of finite rank  $r$ . Additionally, from Lemma 1.1.1 there is a free  $R$ -basis  $B^* = \{e_1^*, e_2^*, \dots, e_r^*\}$  for  $M^*$ , where  $B^*$  has exactly  $r$  elements by Lemma 1.1.3, and also there is a set of non-zero elements  $\{a_1, a_2, \dots, a_r\} \subset R$  such that  $B_N = \{a_1 e_1^*, a_2 e_2^*, \dots, a_r e_r^*\}$  is an  $R$ -basis for  $N$ . Now, by Lemma 1.1.4, for each  $1 \leq i \leq r$  there is a unique element  $f_i \in M$  such that

$$\phi(f_i) = a_i e_i^*.$$

So, the set  $B_M = \{f_1, f_2, \dots, f_r\}$  is an  $R$ -basis for  $M$  because  $\phi$  is an isomorphism. Finally, by definition of  $\phi$  we have that  $\phi(f_i) = (f_i, \cdot)$  for each  $1 \leq i \leq r$ , and then

$$(f_i, \cdot) = a_i e_i^*$$

for each  $1 \leq i \leq r$ . □

REMARK 1.1.6. *In the previous lemma the  $R$ -elements  $\{a_1, a_2, \dots, a_r\}$  also satisfy the divisibility relation  $a_1 | a_2 | \dots | a_r$ , because they are given by Lemma 1.1.1.*

Now, the main result of this section, known as *Jantzen sum formula*.

THEOREM 1.1.7. *Let  $R$  be a principal ideal domain and  $p \in R$  prime. Let  $M$  be a free  $R$ -module of finite rank  $r$ , equipped with a non-degenerate symmetric bilinear form  $(\cdot, \cdot)$  of non-zero determinant  $D$  with respect to some  $R$ -basis for  $M$ . Let  $v_p$ ,  $M(n)$ ,  $\overline{R}$  and  $\overline{M(n)}$  be defined as before. Then the following equality holds:*

$$v_p(D) = \sum_{n \geq 1} \dim_R \overline{M(n)}.$$

*Proof:* From Lemma 1.1.5 there are:

- A free  $R$ -basis  $B^* = \{e_1^*, e_2^*, \dots, e_r^*\}$  for  $M^*$ .
- A free  $R$ -basis  $B_1 = \{f_1, f_2, \dots, f_r\}$  for  $M$ .
- A set of nonzero elements  $\{a_1, a_2, \dots, a_r\} \subset R$  such that

$$(f_i, \cdot) = a_i e_i^*.$$

Let  $B = \{e_1, e_2, \dots, e_r\}$  be the  $R$ -dual basis for  $M$  with respect to  $B^*$ , i.e.,

$$e_j^*(e_i) = \delta_{ij}$$

where  $\delta_{ij}$  is the *Kronecker delta*. Let  $n$  be a non-negative integer. First of all, we need to know how  $M(n)$  is generated, and then apply reduction modulo  $p$  to obtain a basis for  $\overline{M(n)}$ . So, let  $f \in M$ . Since  $B_1$  is basis for  $M$ , there are elements  $\{c_1, c_2, \dots, c_r\} \in R$  such that

$$f = \sum_{i=1}^r c_i f_i.$$

So,

$$\begin{aligned}
f \in M(n) &\Leftrightarrow (f, M) \subset p^n R \\
&\Leftrightarrow (f, e_i) \in p^n R \quad \forall i \\
&\Leftrightarrow \left( \sum_{j=1}^r c_j f_j, e_i \right) \in p^n R \quad \forall i \\
&\Leftrightarrow \sum_{j=1}^r c_j (f_j, e_i) \in p^n R \quad \forall i \\
&\Leftrightarrow \sum_{j=1}^r c_j a_j e_j^*(e_i) \in p^n R \quad \forall i \\
&\Leftrightarrow \sum_{j=1}^r c_j a_j \delta_{ji} \in p^n R \quad \forall i \\
&\Leftrightarrow c_i a_i \in p^n R \quad \forall i \\
&\Leftrightarrow v_p(c_i a_i) \geq n \quad \forall i \\
&\Leftrightarrow v_p(c_i) + v_p(a_i) \geq n \quad \forall i \\
&\Leftrightarrow v_p(c_i) \geq n - v_p(a_i) \quad \forall i
\end{aligned}$$

Here, we have two possibilities for each  $c_i$ :

- If  $n - v_p(a_i) \leq 0$  then  $v_p(c_i) \geq 0$ , and this implies that  $c_i \in R$  without restrictions.
- If  $n - v_p(a_i) > 0$  then  $v_p(c_i) \geq n - v_p(a_i) > 0$ , and this implies that  $c_i \in p^{n-v_p(a_i)} R$ .

So, we have

$$M(n) = \bigoplus_{i: n-v_p(a_i) \leq 0} R f_i \oplus \bigoplus_{i: n-v_p(a_i) > 0} p^{n-v_p(a_i)} f_i,$$

and applying reduction modulo  $p$  on this equality we obtain that

$$\overline{M(n)} = \bigoplus_{i: n-v_p(a_i) \leq 0} \overline{R} f_i,$$

and this implies that

$$\dim_{\overline{R}} \overline{M(n)} = \#\{i : n - v_p(a_i) \leq 0\}.$$

With this, we have the following expression for the right-side of the sum formula desired:

$$\begin{aligned}
\sum_{n \geq 1} \dim_{\overline{R}} \overline{M(n)} &= \sum_{n \geq 1} \#\{i : n - v_p(a_i) \leq 0\} \\
&= \sum_{n=1}^r \#\{i : n - v_p(a_i) \leq 0\} \\
&= \sum_{n=1}^r v_p(a_i).
\end{aligned}$$

Let  $D$  be the determinant of the associated matrix for  $(\cdot, \cdot)$  with respect to  $B$ . We show that  $D = \sum_{n=1}^r v_p(a_i)$ . Since  $B_1$  is also a basis for  $M$ , there is a matrix  $X = (x_{i,j}) \in \text{GL}_r(R)$  such that for each  $j \in \{1, 2, \dots, r\}$

$$e_j = \sum_{k=1}^r x_{k,j} f_k.$$

So,

$$\begin{aligned}
D &= \det \left( (e_i, e_j) \right)_{1 \leq i, j \leq r} \\
&= \det \left( \left( e_i, \sum_{k=1}^r x_{k,j} f_k \right) \right)_{1 \leq i, j \leq r} \\
&= \det \left( \sum_{k=1}^r x_{k,j} (e_i, f_k) \right)_{1 \leq i, j \leq r} \\
&= \det \left( \sum_{k=1}^r x_{k,j} (f_k, e_i) \right)_{1 \leq i, j \leq r} \\
&= \det \left( \sum_{k=1}^r x_{k,j} a_k e_k^*(e_i) \right)_{1 \leq i, j \leq r} \\
&= \det \left( \sum_{k=1}^r x_{k,j} a_k \delta_{ki} \right)_{1 \leq i, j \leq r} \\
&= \det (x_{i,j} a_i)_{1 \leq i, j \leq r} \\
&= \prod_{i=1}^r a_i \cdot \det (x_{i,j})_{1 \leq i, j \leq r} \\
&= \prod_{i=1}^r a_i \cdot \det(X),
\end{aligned}$$

but  $\det(X)$  is a unit of  $R$  because  $X \in \text{GL}_r(R)$ . Then, modulo multiplication by units, we have that

$$D = \prod_{i=1}^r a_i$$

and therefore

$$v_p(D) = v_p \left( \prod_{i=1}^r a_i \right) = \sum_{i=1}^r v_p(a_i) = \sum_{n=1}^{\infty} \dim_{\overline{R}} \overline{M(n)}.$$

□

From the Jantzen sum formula of Theorem 1.1.7 we know that the determinant  $D$  of the associated matrix for the bilinear form  $(\cdot, \cdot)$ , denoted by  $M_{(\cdot, \cdot)}$  contains information about how the  $R$ -modules  $M(n)$  are generated, and so on, about how the  $\overline{R}$ -modules  $\overline{M(n)}$  are generated. In other words, knowing the associated matrix for  $(\cdot, \cdot)$  we can find values for  $\dim_R M(n)$  and  $\dim_{\overline{R}} \overline{M(n)}$ , for each non-negative integer  $n$ . Moreover, from Lemma 1.1.4 we have that the elements  $\{a_1, a_2, \dots, a_r\}$  correspond to the diagonal of the Smith Normal Form, denoted by  $M_d$ , of  $M_{(\cdot, \cdot)}$ , that is:

$$M_d = \begin{bmatrix} a_1 & 0 & 0 & \dots & 0 \\ 0 & a_2 & 0 & \dots & 0 \\ \vdots & \vdots & \vdots & \ddots & \vdots \\ 0 & 0 & 0 & \dots & a_r \end{bmatrix}.$$

So, knowing  $M_d$  we can find values for  $\dim_R M(n)$  and  $\dim_{\overline{R}} \overline{M(n)}$ , and then obtain a sum formula.

EXAMPLE 1. Let  $M$  be a  $\mathbb{Z}$ -module with basis  $\{e_1, e_2, e_3\}$ , equipped by a non-degenerate symmetric bilinear form  $(\cdot, \cdot)$  with associated matrix

$$M_{(\cdot, \cdot)} = \begin{bmatrix} 5 & -2 & 7 \\ -2 & 0 & -2 \\ 7 & -2 & 1 \end{bmatrix}.$$

The Smith Normal Form of  $M_{(\cdot, \cdot)}$  is

$$M_d = \begin{bmatrix} 1 & 0 & 0 \\ 0 & 4 & 0 \\ 0 & 0 & 8 \end{bmatrix},$$

then  $D = \det(M_d) = 32$ . If we consider  $p = 2$ , then  $v_p(D) = 5$ . Now, seeing  $M_d$  we give the following information about the  $\mathbb{Z}$ -modules  $M(n)$ :

$$\begin{aligned} M(0) &= M \\ M(1) &= \{m \in M : (m, M) \subset 2\mathbb{Z}\} \\ &= \text{Span}_{\mathbb{Z}}\langle 2b_1, b_2, b_3 \rangle \\ M(2) &= \{m \in M : (m, M) \subset 4\mathbb{Z}\} \\ &= \text{Span}_{\mathbb{Z}}\langle 4b_1, b_2, b_3 \rangle \\ M(3) &= \{m \in M : (m, M) \subset 8\mathbb{Z}\} \\ &= \text{Span}_{\mathbb{Z}}\langle 8b_1, 2b_2, b_3 \rangle \\ M(k) &= \{m \in M : (m, M) \subset 2^k\mathbb{Z}\} \\ &= \text{Span}_{\mathbb{Z}}\langle 2^k b_1, 2^{k-2} b_2, 2^{k-3} b_3 \rangle \text{ para } k > 3 \end{aligned}$$

where  $\{b_1, b_2, b_3\}$  is another basis for  $M$  obtained after the diagonalization process to get  $M_d$ . Therefore, applying reduction modulo  $p = 2$  we obtain information about the  $\overline{M(n)}$  modules:

$$\begin{aligned} \overline{M(0)} &= \overline{M} \\ \overline{M(1)} &= \text{Span}_{\mathbb{F}_2}\langle \overline{b_2}, \overline{b_3} \rangle \\ \overline{M(2)} &= \text{Span}_{\mathbb{F}_2}\langle \overline{b_2}, \overline{b_3} \rangle \\ \overline{M(3)} &= \text{Span}_{\mathbb{F}_2}\langle \overline{b_3} \rangle \\ \overline{M(k)} &= \overline{0} \text{ para } k > 3 \end{aligned}$$

where we can verify the Jantzen sum formula:

$$\sum_{i>0} \dim_{\overline{\mathbb{R}}} \overline{M(i)} = 2 + 2 + 1 = v_p(D).$$

## 2. Cellular algebras

In this section we recall some definitions and examples related to the concept of *Cellular Algebra*, which was introduced for the first time by Graham and Lehrer in [15]. This concept is fundamental in our thesis because all algebras considered in this work are cellular algebras, so, to study these algebras from the perspective of *cellularity* will be very useful in order to reach our main goal.

DEFINITION 1.2.1. *Let  $\mathcal{A}$  be a finite dimensional algebra over a commutative ring  $\mathbb{k}$  with unity. Then a cellular basis structure for  $\mathcal{A}$  consists of a triple  $(\Lambda, \text{Tab}, C)$ , called cell datum for  $\mathcal{A}$ , such that  $\Lambda$  is a poset with ordering given by  $<$ ,  $\text{Tab}$  is a function on  $\Lambda$  with values in finite sets and  $C : \coprod_{\lambda \in \Lambda} \text{Tab}(\lambda) \times \text{Tab}(\lambda) \rightarrow \mathcal{A}$  is an injection such that*

$$\{C_{st}^\lambda \mid s, t \in \text{Tab}(\lambda), \lambda \in \Lambda\}$$

*is a  $\mathbb{k}$ -basis for  $\mathcal{A}$ : the cellular basis for  $\mathcal{A}$ . The rule  $(C_{st}^\lambda)^* := C_{ts}^\lambda$  defines a  $\mathbb{k}$ -linear antihomomorphism of  $\mathcal{A}$  and the structure constants for  $\mathcal{A}$  with respect to  $\{C_{st}^\lambda\}$  satisfy the following condition with respect to the partial order: for all  $a \in \mathcal{A}$  we have*

$$aC_{st}^\lambda = \sum_{u \in \text{Tab}(\lambda)} r_{usa} C_{ut}^\lambda \pmod{A^{<\lambda}} \quad (1.1)$$

where  $A^{<\lambda}$  is the  $\mathbb{k}$ -submodule of  $\mathcal{A}$  spanned by the set  $\{C_{st}^\mu \mid s, t \in \text{Tab}(\lambda) \text{ and } \mu < \lambda\}$  and where  $r_{usa} \in \mathbb{k}$ .

In each cellular algebra there are the following modules.

DEFINITION 1.2.2. Let  $\mathcal{A}$  a cellular algebra with cell datum  $(\Lambda, \text{Tab}, C)$ . For  $\lambda \in \Lambda$  we define the cell module  $\Delta(\lambda)$  as the  $\mathbb{k}$ -module with basis given by the symbols  $\{C_s^\lambda \mid s \in \text{Tab}(\lambda)\}$  and  $\mathcal{A}$ -action given by the equality

$$aC_s^\lambda = \sum_{u \in \text{Tab}(\lambda)} r_{usa} C_u^\lambda \pmod{A^{<\lambda}} \quad (1.2)$$

where  $r_{usa} \in \mathbb{k}$  are the same scalars of Definition 1.2.1 (which not depend of  $t$  in the previous definition).

Additionally, a cell module  $\Delta(\lambda)$  can be equipped by the following bilinear form.

DEFINITION 1.2.3. Let  $\mathcal{A}$  a cellular algebra with cell datum  $(\Lambda, \text{Tab}, C)$ , and let  $\lambda \in \Lambda$ . Then, for the cell module  $\Delta(\lambda)$  we define the bilinear form  $\langle \cdot, \cdot \rangle_\lambda$  using the following equality

$$C_{as}^\lambda C_{tb}^\lambda = \langle C_s^\lambda, C_t^\lambda \rangle_\lambda C_{ab}^\lambda \pmod{A^{<\lambda}} \quad (1.3)$$

where  $a, b, s, t \in \text{Tab}(\lambda)$ .

LEMMA 1.2.4. In Equation 1.3, the value of  $\langle C_s^\lambda, C_t^\lambda \rangle_\lambda$  doesn't depend on the elements  $a, b \in \text{Tab}(\lambda)$  chosen.

*Proof:* Applying the  $\mathcal{A}$ -action defined in 1.1 to the product  $C_{as}^\lambda C_{tb}^\lambda$  we have that

$$C_{as}^\lambda C_{tb}^\lambda = \sum_{u \in \text{Tab}(\lambda)} r_{utC_{as}^\lambda} C_{ub}^\lambda \pmod{A^{<\lambda}} \quad (1.4)$$

and by the equality 1.3 we have that

$$\langle C_s^\lambda, C_t^\lambda \rangle_\lambda = r_{atC_{as}^\lambda}, \quad (1.5)$$

and therefore  $\langle C_s^\lambda, C_t^\lambda \rangle_\lambda$  doesn't depend of  $b$ . On the other hand, applying the anti-homomorphism  $*$  on 1.3 we have that

$$C_{bt}^\lambda C_{sa}^\lambda = \langle C_s^\lambda, C_t^\lambda \rangle_\lambda C_{ba}^\lambda \pmod{A^{<\lambda}} \quad (1.6)$$

but by 1.1 the product  $C_{bt}^\lambda C_{sa}^\lambda$  is

$$C_{bt}^\lambda C_{sa}^\lambda = \sum_{u \in \text{Tab}(\lambda)} r_{usC_{bt}^\lambda} C_{ua}^\lambda \pmod{A^{<\lambda}}, \quad (1.7)$$

which implies that

$$\langle C_s^\lambda, C_t^\lambda \rangle_\lambda = r_{bsC_{bt}^\lambda}, \quad (1.8)$$

and therefore  $\langle C_s^\lambda, C_t^\lambda \rangle_\lambda$  doesn't depend of  $a$ .  $\square$

The following lemma is a property of the bilinear form  $\langle \cdot, \cdot \rangle_\lambda$ .

LEMMA 1.2.5. The bilinear form  $\langle \cdot, \cdot \rangle_\lambda$  of  $\Delta(\lambda)$  is symmetric. In other words,

$$\langle C_s^\lambda, C_t^\lambda \rangle_\lambda = \langle C_t^\lambda, C_s^\lambda \rangle_\lambda \quad (1.9)$$

for all  $s, t \in \text{Tab}(\lambda)$ .

*Proof:* Let  $s, t \in \text{Tab}(\lambda)$ . By Definition 1.2.3 we have the equalities

$$C_{as}^\lambda C_{tb}^\lambda = \langle C_s^\lambda, C_t^\lambda \rangle_\lambda C_{ab}^\lambda \pmod{A^{<\lambda}} \quad (1.10)$$

$$C_{a't}^\lambda C_{s'b'}^\lambda = \langle C_t^\lambda, C_s^\lambda \rangle_\lambda C_{a'b'}^\lambda \pmod{A^{<\lambda}} \quad (1.11)$$

for any  $a, a', b, b' \in \text{Tab}(\lambda)$ . So, if we consider  $a = b' = t$  and  $b = a' = s$  then the equalities (1.10) and (1.11) implies the following equalities, respectively:

$$C_{ts}^\lambda C_{ts}^\lambda = \langle C_s^\lambda, C_t^\lambda \rangle_\lambda C_{ts}^\lambda \pmod{A^{<\lambda}} \quad (1.12)$$

$$C_{st}^\lambda C_{st}^\lambda = \langle C_t^\lambda, C_s^\lambda \rangle_\lambda C_{st}^\lambda \pmod{A^{<\lambda}}. \quad (1.13)$$

Now, applying the anti-homomorphism  $*$  on (1.12) and considering that  $r^* \in A^{<\lambda}$  for all  $r \in A^{<\lambda}$  we have that

$$\begin{aligned} C_{ts}^\lambda C_{ts}^\lambda &= \langle C_s^\lambda, C_t^\lambda \rangle_\lambda C_{ts}^\lambda \pmod{A^{<\lambda}} \xrightarrow{*} \left( C_{ts}^\lambda C_{ts}^\lambda \right)^* = \langle C_s^\lambda, C_t^\lambda \rangle_\lambda \left( C_{ts}^\lambda \right)^* \pmod{A^{<\lambda}} \\ &\Rightarrow C_{st}^\lambda C_{st}^\lambda = \langle C_s^\lambda, C_t^\lambda \rangle_\lambda C_{st}^\lambda \pmod{A^{<\lambda}}. \end{aligned} \quad (1.14)$$

Therefore, from equalities (1.13) and (1.14) we have that  $\langle C_s^\lambda, C_t^\lambda \rangle_\lambda = \langle C_t^\lambda, C_s^\lambda \rangle_\lambda$ .  $\square$

The previous definitions are abstract. So, for understanding them we consider it necessary to give a *classical* example. In this thesis we shall consider several diagram algebras which are also cellular algebras. Possibly the oldest and most studied diagram algebra is the Temperley-Lieb algebra. It arose in statistical mechanics in the seventies. In the present thesis we shall use the following variation of it.

Let  $R = \mathbb{C}$ .

DEFINITION 1.2.6. *The Temperley-Lieb algebra  $\mathbb{T}\mathbb{L}_n$  with loop-parameter  $-2$  is the  $R$ -algebra on the generators  $\mathbb{U}_1, \dots, \mathbb{U}_{n-1}$  subject to the relations*

$$\mathbb{U}_i^2 = -2\mathbb{U}_i \quad \text{if } 1 \leq i < n \quad (1.15)$$

$$\mathbb{U}_i \mathbb{U}_j \mathbb{U}_i = \mathbb{U}_i \quad \text{if } |i - j| = 1 \quad (1.16)$$

$$\mathbb{U}_i \mathbb{U}_j = \mathbb{U}_j \mathbb{U}_i \quad \text{if } |i - j| > 1. \quad (1.17)$$

As already indicated,  $\mathbb{T}\mathbb{L}_n$  is a diagram algebra. This fact plays an important role in our thesis, and let us briefly explain it. The diagram basis for  $\mathbb{T}\mathbb{L}_n$  as diagram algebra consists of *Temperley-Lieb diagrams* on  $n$  points, which are planar pairings between  $n$  northern points and  $n$  southern points of a rectangle. The multiplication  $D_1 D_2$  of two diagrams  $D_1$  and  $D_2$  is given by concatenation of them, with  $D_2$  on top of  $D_1$ . This concatenation process may give rise to internal loops, which are removed from a diagram by multiplying it by  $-2$ . For example, if we consider the elements

$$D_1 = \begin{array}{c} \text{Diagram 1} \\ \in \mathbb{T}\mathbb{L}_6 \end{array} \text{ and } D_2 = \begin{array}{c} \text{Diagram 2} \\ \in \mathbb{T}\mathbb{L}_6 \end{array} \quad (1.18)$$

we have that

$$D_1 D_2 = \begin{array}{c} \text{Diagram 3} \\ = (-2)^2 \end{array} \begin{array}{c} \text{Diagram 4} \end{array} \quad (1.19)$$

The isomorphism between  $\mathbb{T}\mathbb{L}_n$  and its diagrammatic version can be reviewed for more details in, for example, [26] and [27]. So, under this isomorphism, we have that

$$1 \mapsto \begin{array}{c} | \\ | \\ | \\ \dots \\ | \\ | \\ | \end{array} \text{ and } \mathbb{U}_i \mapsto \begin{array}{c} | \\ | \\ | \\ \dots \\ \cup \\ \dots \\ \cap \\ | \\ | \\ | \end{array}. \quad (1.20)$$

From now on, simply we use  $1$  and  $\mathbb{U}_i$  for the diagrams generators of the diagrammatic version of  $\mathbb{T}\mathbb{L}_n$ .

We now return to the *cellularity* concepts. To make  $\mathbb{T}\mathbb{L}_n$  fit into this language we choose the following cell datum for  $\mathbb{T}\mathbb{L}_n$ :

- $\mathbb{k} = R$ .
- $\Lambda = \Lambda_n := \{n, n-2, \dots, 1\}$  (or  $\Lambda := \Lambda_n = \{n, n-2, \dots, 2, 0\}$ ) if  $n$  is odd (or even), with poset structure inherited from  $\mathbb{Z}$ .
- For  $\lambda \in \Lambda_n$  we choose  $\text{Tab}(\lambda)$  to be Temperley-Lieb *half-diagrams* with  $\lambda$  *propagating* lines, that is Temperley-Lieb diagrams on  $\lambda$  northern and  $n$  southern points in which each northern point is paired with a southern point.
- For  $s, t \in \text{Tab}(\lambda)$  we define  $C_{st}^\lambda$  to be the diagram obtained from gluing  $s$  and the horizontal reflection of  $t$  (denoted by  $t^*$ ), with  $s$  on the bottom. In other words,  $C_{st}^\lambda = st^*$ . Here is an example of this gluing process with  $n = 8$  and  $s, t \in \text{Tab}(2)$ :

$$(s, t) = \left( \begin{array}{c} \text{Diagram 1} \\ \text{Diagram 2} \end{array} \right) \mapsto C_{st}^\lambda = st^* = \begin{array}{c} \text{Diagram 3} \\ \text{Diagram 4} \end{array}. \quad (1.21)$$

With the above cell datum selection for  $\mathbb{T}\mathbb{L}_n$  we have the following result.

**THEOREM 1.2.7.** *The above triple  $(\Lambda_n, \text{Tab}, C)$  makes  $\mathbb{T}\mathbb{L}_n$  into a cellular algebra.*

*Proof:* This follows directly from the definitions.  $\square$

Now, considering the importance of  $\Delta(\lambda)$  and its bilinear form  $\langle \cdot, \cdot \rangle_\lambda$  for the representation theory of  $\mathbb{T}\mathbb{L}_n$  mentioned in the introduction, we need to describe in another way the bilinear form, or in other words, how the bilinear form is calculated under the cell datum selected. From now on, we denote by  $\mathbf{1}_n$  the identity on  $\mathbb{T}\mathbb{L}_n$ .

Fix a  $\lambda \in \Lambda$ . First, a property in  $\text{Tab}$ .

**LEMMA 1.2.8.** *Let  $s \in \text{Tab}(\lambda)$ . Then*

$$s^*s = (-2)^{\frac{n-\lambda}{2}} \mathbf{1}_\lambda. \quad (1.22)$$

*Proof:* From the definition of  $\text{Tab}$  we have that  $s$  has  $\frac{n-\lambda}{2}$  arcs and  $\lambda$  propagating lines, where *arc* means pairing between two southern points of  $s$ . Furthermore, the  $s^*s$  diagram connects each propagation line of  $s$  with its own image under the horizontal reflection. So  $s^*s$  again has  $\lambda$  lines of propagation. On the other hand, the diagram  $s^*s$  connects all the arcs of  $s$  to its own image under the horizontal reflection, generating a loop for each arc of  $s$ . So,  $s^*s$  has exactly  $\frac{n-\lambda}{2}$  loops, and therefore

$$s^*s = (-2)^{\frac{n-\lambda}{2}} \mathbf{1}_\lambda. \quad \square$$

Now, a particular description of  $\langle \cdot, \cdot \rangle_\lambda$  in  $\mathbb{T}\mathbb{L}_n$ . For this, we denote  $\text{coef}_{\mathbf{1}_\lambda}(D)$  to the coefficient of  $\mathbf{1}_\lambda$  in the expansion of  $D$  in terms of the cellular basis.

**LEMMA 1.2.9.** *Let  $s, t \in \text{Tab}(\lambda)$ . Then  $\langle C_s^\lambda, C_t^\lambda \rangle_\lambda = \text{coef}_{\mathbf{1}_\lambda}(C_{s^*t^*}^\lambda)$ .*

*Proof:* Let  $s, t \in \text{Tab}(\lambda)$ . By Definition 1.2.3 we have that

$$C_{as}^\lambda C_{tb}^\lambda = \langle C_s^\lambda, C_t^\lambda \rangle_\lambda C_{ab}^\lambda \pmod{A^{<\lambda}} \quad (1.23)$$

for any  $a, b \in \text{Tab}(\lambda)$ , and by cell datum setting chosen for  $\mathbb{T}\mathbb{L}_n$  we have from (1.23) that

$$as^*tb^* = \langle C_s^\lambda, C_t^\lambda \rangle_\lambda ab^* \pmod{A^{<\lambda}} \quad (1.24)$$

for any  $a, b \in \text{Tab}(\lambda)$ . Now, if we multiply by  $a^*$  on the left side in (1.24) and by  $b$  on the right side in (1.24), and applying Lemma 1.2.8 we have that

$$s^*t = \langle C_s^\lambda, C_t^\lambda \rangle_\lambda \mathbf{1}_\lambda \pmod{A^{<\lambda}}, \quad (1.25)$$

because  $qr \in A^{<\lambda}$  for all  $q \in \text{Tab}(\lambda)$  and for all  $r \in A^{<\lambda}$ . Therefore, the previous equality implies that  $\langle C_s^\lambda, C_t^\lambda \rangle_\lambda$  is

the coefficient of  $\mathbf{1}_\lambda$  in the diagram  $s^* t$ , but  $s^* t = C_{s^* t}^\lambda$ . This completes the proof.  $\square$

The last Lemma is very useful for calculating values of the bilinear form bypassing its definition. It is important to say that analogues of Lemma 1.2.9 holds for others cellular algebras which we will use in the next chapter.

### 3. The Jones-Wenzl elements in Temperley-Lieb algebra

In this section we discuss the Jones-Wenzl elements in Temperley-Lieb diagram algebra  $\mathbb{T}\mathbb{L}_n$ , their construction and some useful properties for our thesis. For this, we consider some notations.

If  $D_1$  and  $D_2$  are two diagrams of  $\mathbb{T}\mathbb{L}_n$  we use the tensor product  $D_1 \otimes D_2$  for horizontal concatenation, with  $D_2$  on the right of  $D_1$ . Now, in this case, we consider the following definition of these elements, which was used in [43].

DEFINITION 1.3.1. *Define the Jones-Wenzl elements in  $\mathbb{T}\mathbb{L}_n$  via the following recursion relation:*

$$\mathbf{JW}_1 = \mathbf{1}_1 \quad (1.26)$$

and

$$\mathbf{JW}_n = \mathbf{JW}_{n-1} \otimes \mathbf{1}_1 + \frac{n-1}{n} (\mathbf{JW}_{n-1} \otimes \mathbf{1}_1) \cup_{n-1} (\mathbf{JW}_{n-1} \otimes \mathbf{1}_1). \quad (1.27)$$

In the diagram representation, we use the standard rectangle notation to indicate  $\mathbf{JW}_n$ , as follows:

$$\begin{array}{c} | \\ \boxed{\mathbf{JW}_1} \\ | \end{array} = \begin{array}{c} | \\ | \\ | \end{array} \quad (1.28)$$

and

$$\begin{array}{c} | \quad | \quad | \quad \dots \quad | \\ \boxed{\mathbf{JW}_n} \\ | \quad | \quad | \quad \dots \quad | \end{array} = \begin{array}{c} | \quad | \quad | \quad \dots \quad | \\ \boxed{\mathbf{JW}_{n-1}} \\ | \quad | \quad | \quad \dots \quad | \end{array} + \frac{n-1}{n} \begin{array}{c} \dots \quad | \quad | \\ \boxed{\mathbf{JW}_{n-1}} \\ \dots \\ \boxed{\mathbf{JW}_{n-1}} \\ \dots \quad | \quad | \end{array} \quad (1.29)$$

These elements have several useful properties for our thesis.

LEMMA 1.3.2. *For a positive integer  $n > 1$  the following equality holds:*

$$(\mathbf{JW}_{n-1} \otimes \mathbf{1}_2) \cup_n = \cup_n (\mathbf{JW}_{n-1} \otimes \mathbf{1}_2) \quad (1.30)$$

*Proof:* Direct from definition.  $\square$

LEMMA 1.3.3. *For a positive integer  $n$  we have the following equalities:*

$$\mathbf{JW}_n^2 = \mathbf{JW}_n, \quad (1.31)$$

$$\left( \cup_n (\mathbf{JW}_n \otimes \mathbf{1}_1) \right)^2 = -\frac{n+1}{n} \cup_n (\mathbf{JW}_n \otimes \mathbf{1}_1). \quad (1.32)$$

and

$$\left( (\mathbf{JW}_n \otimes \mathbf{1}_1) \cup_n \right)^2 = -\frac{n+1}{n} (\mathbf{JW}_n \otimes \mathbf{1}_1) \cup_n. \quad (1.33)$$

In diagrams, equations (1.31), (1.32) and (1.33) are the following equalities respectively:



$$(1.34)$$

$$(1.35)$$

$$(1.36)$$

*Proof:* By induction on  $n$ . We only show the proof of equalities (1.31) and (1.32), because the proof of (1.33) is similar to the proof of (1.32). We start with the initial case  $n = 1$ . For the first equality we have that

$$\mathbf{JW}_1^2 = \mathbf{1}_1^2 = \mathbf{1}_1 = \mathbf{JW}_1.$$

For the second equality, we have that its left side is

$$\left( \cup_1 (\mathbf{JW}_1 \otimes \mathbf{1}_1) \right)^2 = (\cup_1 \mathbf{1}_1 \otimes \mathbf{1}_1)^2 = (\cup \mathbf{1}_2)^2 = \cup_1^2 = -2\cup_1$$

and its right side is

$$-\frac{1+1}{1} \cup_1 (\mathbf{JW}_1 \otimes \mathbf{1}_1) = -2\cup_1 \mathbf{1}_2 = -2\cup_1,$$

therefore, (1.31) and (1.32) hold for  $n = 1$ . Now, we assume by induction that

$$\mathbf{JW}_{n-1}^2 = \mathbf{JW}_{n-1} \quad (1.37)$$

and

$$\left( \cup_{n-1} (\mathbf{JW}_{n-1} \otimes \mathbf{1}_1) \right)^2 = -\frac{n}{n-1} \cup_{n-1} (\mathbf{JW}_{n-1} \otimes \mathbf{1}_1). \quad (1.38)$$

By the recursion formula from (1.27) for  $\mathbf{JW}_n$  and applying the idempotence of  $\mathbf{JW}_{n-1}$  we have that

$$(\mathbf{JW}_{n-1} \otimes \mathbf{1}_1) \mathbf{JW}_n = \mathbf{JW}_n (\mathbf{JW}_{n-1} \otimes \mathbf{1}_1) = \mathbf{JW}_n. \quad (1.39)$$

To obtain (1.32), we consider the following equality from the definition:

$$\cup_n(\mathbf{JW}_n \otimes \mathbf{1}_1) = \cup_n(\mathbf{JW}_{n-1} \otimes \mathbf{1}_2) + \frac{n-1}{n} \cup_n(\mathbf{JW}_{n-1} \otimes \mathbf{1}_2) \cup_{n-1}(\mathbf{JW}_{n-1} \otimes \mathbf{1}_2) \quad (1.40)$$

and multiplying (1.40) by  $\cup_n$  we have that

$$\begin{aligned} \cup_n(\mathbf{JW}_n \otimes \mathbf{1}_1) \cup_n &= \cup_n(\mathbf{JW}_{n-1} \otimes \mathbf{1}_2) \cup_n + \frac{n-1}{n} \cup_n(\mathbf{JW}_{n-1} \otimes \mathbf{1}_2) \cup_{n-1}(\mathbf{JW}_{n-1} \otimes \mathbf{1}_2) \cup_n \\ &\stackrel{(1.30)}{=} -2 \cup_n(\mathbf{JW}_{n-1} \otimes \mathbf{1}_2) + \frac{n-1}{n} (\mathbf{JW}_{n-1} \otimes \mathbf{1}_2) \cup_n(\mathbf{JW}_{n-1} \otimes \mathbf{1}_2). \end{aligned}$$

Therefore, multiplying the last equality by  $(\mathbf{JW}_n \otimes \mathbf{1}_1)$  we obtain

$$\begin{aligned} (\cup_n(\mathbf{JW}_n \otimes \mathbf{1}_1))^2 &= -2 \cup_n(\mathbf{JW}_{n-1} \otimes \mathbf{1}_2) (\mathbf{JW}_n \otimes \mathbf{1}_1) + \frac{n-1}{n} (\mathbf{JW}_{n-1} \otimes \mathbf{1}_2) \cup_n(\mathbf{JW}_{n-1} \otimes \mathbf{1}_2) (\mathbf{JW}_n \otimes \mathbf{1}_1) \\ &\stackrel{(1.30), (1.39)}{=} -2 \cup_n(\mathbf{JW}_n \otimes \mathbf{1}_1) + \frac{n-1}{n} \cup_n(\mathbf{JW}_{n-1} \otimes \mathbf{1}_2)^2 (\mathbf{JW}_n \otimes \mathbf{1}_1) \\ &\stackrel{(1.37), (1.30)}{=} -2 \cup_n(\mathbf{JW}_n \otimes \mathbf{1}_1) + \frac{n-1}{n} \cup_n(\mathbf{JW}_n \otimes \mathbf{1}_1) \\ &= -\frac{n+1}{n} \cup_n(\mathbf{JW}_n \otimes \mathbf{1}_1), \end{aligned}$$

then, by induction, (1.32) holds for every positive integer  $n$ . On the other hand:

$$\begin{aligned} \mathbf{JW}_n^2 &= \left( (\mathbf{JW}_{n-1} \otimes \mathbf{1}_1) + \frac{n-1}{n} (\mathbf{JW}_{n-1} \otimes \mathbf{1}_1) \cup_{n-1}(\mathbf{JW}_{n-1} \otimes \mathbf{1}_1) \right)^2 \\ &= (\mathbf{JW}_{n-1} \otimes \mathbf{1}_1)^2 + \frac{n-1}{n} (\mathbf{JW}_{n-1} \otimes \mathbf{1}_1)^2 \cup_{n-1}(\mathbf{JW}_{n-1} \otimes \mathbf{1}_1) + \frac{n-1}{n} (\mathbf{JW}_{n-1} \otimes \mathbf{1}_1) \cup_{n-1}(\mathbf{JW}_{n-1} \otimes \mathbf{1}_1)^2 \\ &\quad + \left( \frac{n-1}{n} \right)^2 (\mathbf{JW}_{n-1} \otimes \mathbf{1}_1) \cup_{n-1}(\mathbf{JW}_{n-1} \otimes \mathbf{1}_1) (\mathbf{JW}_{n-1} \otimes \mathbf{1}_1) \cup_{n-1}(\mathbf{JW}_{n-1} \otimes \mathbf{1}_1) \\ &\stackrel{(1.37)}{=} (\mathbf{JW}_{n-1} \otimes \mathbf{1}_1) + \frac{2(n-1)}{n} (\mathbf{JW}_{n-1} \otimes \mathbf{1}_1) \cup_{n-1}(\mathbf{JW}_{n-1} \otimes \mathbf{1}_1) + \left( \frac{n-1}{n} \right)^2 (\mathbf{JW}_{n-1} \otimes \mathbf{1}_1) (\cup_{n-1}(\mathbf{JW}_{n-1} \otimes \mathbf{1}_1))^2 \\ &\stackrel{(1.38)}{=} (\mathbf{JW}_{n-1} \otimes \mathbf{1}_1) + \left( \frac{2(n-1)}{n} + \left( \frac{n-1}{n} \right)^2 \left( \frac{-n}{n-1} \right) \right) (\mathbf{JW}_{n-1} \otimes \mathbf{1}_1) \cup_{n-1}(\mathbf{JW}_{n-1} \otimes \mathbf{1}_1) \\ &= (\mathbf{JW}_{n-1} \otimes \mathbf{1}_1) + \frac{n-1}{n} (\mathbf{JW}_{n-1} \otimes \mathbf{1}_1) \cup_{n-1}(\mathbf{JW}_{n-1} \otimes \mathbf{1}_1) \\ &= \mathbf{JW}_n. \end{aligned}$$

Then, by induction, (1.31) holds for every positive integer  $n$ . □

LEMMA 1.3.4.

$$\cup_i \mathbf{JW}_n = \mathbf{JW}_n \cup_i = 0$$

for all  $1 \leq i < n$ .

*Proof:* By induction on  $n$ . We will show the proof of the equality  $\cup_i \mathbf{JW}_n = 0$ . The initial case is  $n = 2$ , then  $i = 1$ . In this case,

$$\boxed{\mathbf{JW}_2} = \left| \begin{array}{c} | \\ | \\ | \end{array} \right| + \frac{1}{2} \begin{array}{c} \cup \\ \cap \end{array}, \quad (1.41)$$

so,

$$\cup_1 \mathbf{JW}_2 = \begin{array}{c} \boxed{\mathbf{JW}_2} \\ \cup \\ \cup \end{array} = \frac{1}{2} \begin{array}{c} \cup \\ \cup \\ \cup \end{array} + \begin{array}{c} \cup \\ \cup \\ \cup \end{array} = -1 \begin{array}{c} \cup \\ \cup \end{array} + \begin{array}{c} \cup \\ \cup \end{array} = 0.$$

We assume by induction that  $\cup_i \mathbf{JW}_{n-1} = 0$  for all  $i < n-1$ . So,

$$\cup_i \mathbf{JW}_n = \cup_i (\mathbf{JW}_{n-1} \otimes \mathbf{1}_1) + \frac{n-1}{n} \cup_i (\mathbf{JW}_{n-1} \otimes \mathbf{1}_1) \cup_{n-1} (\mathbf{JW}_{n-1} \otimes \mathbf{1}_1). \quad (1.42)$$

Here we have two cases. If  $i \leq n-2$ , then  $\cup_i \mathbf{JW}_n = 0 + \frac{n-1}{n} \cdot 0 \cdot \cup_{n-1} (\mathbf{JW}_{n-1} \otimes \mathbf{1}_1) = 0$  by hypothesis. On the other hand, if  $i = n-1$  then we have that

$$\begin{aligned} \cup_i \mathbf{JW}_n &\stackrel{i=n-1}{=} \cup_{n-1} (\mathbf{JW}_{n-1} \otimes \mathbf{1}_1) + \frac{n-1}{n} \cup_{n-1} (\mathbf{JW}_{n-1} \otimes \mathbf{1}_1) \cup_{n-1} (\mathbf{JW}_{n-1} \otimes \mathbf{1}_1) \\ &= \cup_{n-1} (\mathbf{JW}_{n-1} \otimes \mathbf{1}_1) + \frac{n-1}{n} \left( \cup_{n-1} (\mathbf{JW}_{n-1} \otimes \mathbf{1}_1) \right)^2 \\ &\stackrel{\text{Lemma 1.3.3}}{=} \cup_{n-1} (\mathbf{JW}_{n-1} \otimes \mathbf{1}_1) + \frac{n-1}{n} \cdot \frac{-n}{n-1} \cup_{n-1} (\mathbf{JW}_{n-1} \otimes \mathbf{1}_1) \\ &= 0, \end{aligned}$$

and by induction the equality  $\cup_i \mathbf{JW}_n = 0$  holds. The proof of  $\mathbf{JW}_n \cup_i = 0$  is analogue.  $\square$

LEMMA 1.3.5.

$$\text{coef}_1(\mathbf{JW}_n) = 1, \quad (1.43)$$

where  $\text{coef}_1(\mathbf{JW}_n)$  denotes the coefficient of  $\mathbf{1}_n$  when  $\mathbf{JW}_n$  is expanded in the diagram basis for  $\mathbb{T}\mathbb{L}_n$ .

*Proof:* By induction on  $n$ . The case  $n = 1$  is direct because  $\mathbf{JW}_1 = \mathbf{1}_1$ . Now, we assume by induction that  $\text{coef}_1(\mathbf{JW}_{n-1})$ . So, by definition of  $\mathbf{JW}_n$  we have that

$$\text{coef}_1(\mathbf{JW}_n) = \text{coef}_1 \left( \begin{array}{c} \dots \\ \boxed{\mathbf{JW}_{n-1}} \\ \dots \end{array} \right) + \frac{n-1}{n} \text{coef}_1 \left( \begin{array}{c} \dots \\ \boxed{\mathbf{JW}_{n-1}} \\ \dots \\ \boxed{\mathbf{JW}_{n-1}} \\ \dots \end{array} \right). \quad (1.44)$$

By hypothesis we have that

$$\text{coef}_1 \left( \begin{array}{c} \dots \\ \boxed{\mathbf{JW}_{n-1}} \\ \dots \end{array} \right) = 1$$

and for the other term in (1.44) we have that the diagram  $D = \begin{array}{c} \dots \\ \boxed{\mathbf{JW}_{n-1}} \\ \dots \\ \boxed{\mathbf{JW}_{n-1}} \\ \dots \end{array}$  doesn't contain the  $\mathbf{1}_n$  in its expansion

in terms of the basis. If we suppose that  $D$  contain the  $\mathbf{1}_n$  in its expansion in terms of the basis, then the upper cup and the lower cap in the rightmost side of  $D$  must be connected through the rightmost vertical line between the two  $\mathbf{JW}_{n-1}$  elements of  $D$ . This fact is illustrated with a blue lines in the following image:

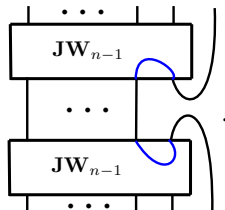

So, if  $\mathbf{1}_n$  appears in this diagram  $D$ , the  $n-2$  vertical lines in the bottom boundary of the  $\mathbf{JW}_{n-1}$  (the  $\mathbf{JW}_{n-1}$  in the south of  $D$ ) should be connected with the  $n-3$  vertical propagating lines from the top boundary of the same  $\mathbf{JW}_{n-1}$ , which is impossible. Therefore,  $\text{coef}_1(D) = 0$  and by induction the lemma is proven.  $\square$

REMARK 1.3.6. *This lemma implies that  $\mathbf{JW}_n$  is a non-zero element of  $\mathbb{T}\mathbb{L}_n$  because  $\text{coef}_1(\mathbf{JW}_n) = 1$  and  $\mathbf{1}_n \notin \text{Span}_{\mathbb{C}}\{\cup_1, \dots, \cup_{n-1}\}$ .*

The last three lemmas give us a characterization of the Jones-Wenzl elements. In other words, we have the following lemma.

LEMMA 1.3.7. *Let  $e$  be a non-zero element in  $\mathbb{T}\mathbb{L}_n$  such that*

- (1)  $e^2 = e$
- (2)  $\cup_i e = e \cup_i = 0$  for all  $1 \leq i < n$ .

*Then  $e = \mathbf{JW}_n$ . In other words,  $\mathbf{JW}_n$  is the unique non-zero element of  $\mathbb{T}\mathbb{L}_n$  that satisfies (1) and (2).*

*Proof:* Let  $\mathcal{U}$  the two-sided ideal generated by  $U_1, \dots, U_{n-1}$ . Since  $e \in \mathbb{T}\mathbb{L}_n$  and  $\mathbf{1}_n \notin \mathcal{U}$ , then there is a scalar  $\alpha \in \mathbb{C}$  such that

$$e = \alpha \mathbf{1}_n + u, \quad (1.45)$$

where  $u \in \mathcal{U}$ . Now, since  $e$  is idempotent by (1) we have that

$$\alpha \mathbf{1}_n + u = (\alpha \mathbf{1}_n + u)^2 = \alpha^2 \mathbf{1}_n + 2\alpha u + u^2,$$

and this implies that  $\alpha = \alpha^2$ . Therefore,  $\alpha = 0$  or  $\alpha = 1$ . If  $\alpha = 0$  then  $e = u$ , and by (1) this fact implies that  $e = e^2 = eu = 0$ , which is a contradiction. Thus  $\alpha = 1$  and

$$e = \mathbf{1}_n + u. \quad (1.46)$$

On the other hand, we have by Lemma 1.3.5 that

$$\mathbf{JW}_n = \mathbf{1}_n + u', \quad (1.47)$$

where  $u' \in \mathcal{U}$ . So, multiplying on the left of (1.46) by  $\mathbf{JW}_n$  and on the right of (1.47) by  $e$  we have the following equalities respectively:

$$\begin{aligned} \mathbf{JW}_n e &= \mathbf{JW}_n \mathbf{1}_n + \mathbf{JW}_n u = \mathbf{JW}_n \\ \mathbf{JW}_n e &= \mathbf{1}_n e + u' e = e, \end{aligned}$$

then  $e = \mathbf{JW}_n$ .  $\square$

Now, a simple but very useful property of  $\mathbf{JW}_n$ , called usually absorption.

LEMMA 1.3.8. *For all  $m \leq n$  the equality*

$$(\mathbf{JW}_m \otimes \mathbf{1}_{n-m}) \mathbf{JW}_n = \mathbf{JW}_n \quad (1.48)$$

*holds.*

*Proof:* By induction on  $n$ . The initial case  $n = 1$  is trivial. Now, we assume by induction that

$$(\mathbf{JW}_m \otimes \mathbf{1}_{n-1-m}) \mathbf{JW}_{n-1} = \mathbf{JW}_{n-1} \quad (1.49)$$

for all  $1 \leq m < n-1$ . In diagrams the hypothesis is:

$$\begin{array}{c} \cdots \quad | \quad \cdots \\ \hline \mathbf{JW}_{n-1} \\ \hline \cdots \quad | \quad \cdots \\ \mathbf{JW}_m \\ \hline \cdots \quad | \quad \cdots \end{array} = \begin{array}{c} \cdots \quad | \quad \cdots \\ \hline \mathbf{JW}_{n-1} \\ \hline \cdots \quad | \quad \cdots \end{array}. \quad (1.50)$$

So, if  $m < n$  we have by definition the following:

$$\begin{aligned}
 (\mathbf{JW}_m \otimes \mathbf{1}_{n-m}) \mathbf{JW}_n &= \begin{array}{c} \text{---} \text{---} \text{---} \text{---} \text{---} \\ | \quad | \quad | \quad | \quad | \\ \boxed{\mathbf{JW}_n} \\ | \quad | \quad | \quad | \quad | \\ \text{---} \text{---} \text{---} \text{---} \text{---} \\ \boxed{\mathbf{JW}_m} \\ | \quad | \quad | \quad | \quad | \\ \text{---} \text{---} \text{---} \text{---} \text{---} \end{array} = \begin{array}{c} \text{---} \text{---} \text{---} \text{---} \text{---} \\ | \quad | \quad | \quad | \quad | \\ \boxed{\mathbf{JW}_{n-1}} \\ | \quad | \quad | \quad | \quad | \\ \text{---} \text{---} \text{---} \text{---} \text{---} \\ \boxed{\mathbf{JW}_m} \\ | \quad | \quad | \quad | \quad | \\ \text{---} \text{---} \text{---} \text{---} \text{---} \end{array} + \frac{n-1}{n} \begin{array}{c} \text{---} \text{---} \text{---} \text{---} \text{---} \\ | \quad | \quad | \quad | \quad | \\ \boxed{\mathbf{JW}_{n-1}} \\ | \quad | \quad | \quad | \quad | \\ \text{---} \text{---} \text{---} \text{---} \text{---} \\ \dots \\ | \quad | \quad | \quad | \quad | \\ \boxed{\mathbf{JW}_{n-1}} \\ | \quad | \quad | \quad | \quad | \\ \text{---} \text{---} \text{---} \text{---} \text{---} \\ \dots \\ | \quad | \quad | \quad | \quad | \\ \boxed{\mathbf{JW}_m} \\ | \quad | \quad | \quad | \quad | \\ \text{---} \text{---} \text{---} \text{---} \text{---} \end{array} \\
 \text{Hypothesis or Lemma 1.3.3} &= \begin{array}{c} \text{---} \text{---} \text{---} \text{---} \text{---} \\ | \quad | \quad | \quad | \quad | \\ \boxed{\mathbf{JW}_{n-1}} \\ | \quad | \quad | \quad | \quad | \\ \text{---} \text{---} \text{---} \text{---} \text{---} \end{array} + \frac{n-1}{n} \begin{array}{c} \text{---} \text{---} \text{---} \text{---} \text{---} \\ | \quad | \quad | \quad | \quad | \\ \boxed{\mathbf{JW}_{n-1}} \\ | \quad | \quad | \quad | \quad | \\ \text{---} \text{---} \text{---} \text{---} \text{---} \\ \dots \\ | \quad | \quad | \quad | \quad | \\ \boxed{\mathbf{JW}_{n-1}} \\ | \quad | \quad | \quad | \quad | \\ \text{---} \text{---} \text{---} \text{---} \text{---} \end{array} \\
 &= \mathbf{JW}_n,
 \end{aligned}$$

and this concludes the proof. □

Finally, we will show another recursive definition for the Jones-Wenzl elements, which will very important in some calculations of this thesis for getting our main result.

LEMMA 1.3.9. *For a positive integer  $n$  the following recursive formula holds:*

$$\begin{array}{c} \text{---} \text{---} \text{---} \text{---} \text{---} \\ | \quad | \quad | \quad | \quad | \\ \boxed{\mathbf{JW}_n} \\ | \quad | \quad | \quad | \quad | \\ \text{---} \text{---} \text{---} \text{---} \text{---} \end{array} = \begin{array}{c} \text{---} \text{---} \text{---} \text{---} \text{---} \\ | \quad | \quad | \quad | \quad | \\ \boxed{\mathbf{JW}_{n-1}} \\ | \quad | \quad | \quad | \quad | \\ \text{---} \text{---} \text{---} \text{---} \text{---} \end{array} + \sum_{j=1}^{n-1} \frac{j}{n} \begin{array}{c} \text{---} \text{---} \text{---} \text{---} \text{---} \\ | \quad | \quad | \quad | \quad | \\ \boxed{\mathbf{JW}_{n-1}} \\ | \quad | \quad | \quad | \quad | \\ \text{---} \text{---} \text{---} \text{---} \text{---} \\ \text{---} \text{---} \text{---} \text{---} \text{---} \\ | \quad | \quad | \quad | \quad | \\ \text{---} \text{---} \text{---} \text{---} \text{---} \end{array} \tag{1.51}$$

where the number  $j$  indicates the position of the arc and the initial case is  $\mathbf{JW}_1 = \mathbf{1}_1$ .

*Proof:* By induction on  $n$ . If  $n = 2$  we have from (1.41) that

$$\begin{array}{c} \text{---} \text{---} \\ | \quad | \\ \boxed{\mathbf{JW}_2} \\ | \quad | \\ \text{---} \text{---} \end{array} = \begin{array}{c} \text{---} \text{---} \\ | \quad | \\ | \quad | \\ | \quad | \\ \text{---} \text{---} \end{array} + \frac{1}{2} \begin{array}{c} \text{---} \text{---} \\ \cup \\ \text{---} \text{---} \\ \cap \\ \text{---} \text{---} \end{array}, \tag{1.52}$$

and the recursive formula (1.51) we have that

$$\frac{1}{2} \begin{array}{c} \text{---} \text{---} \\ \cup \\ \text{---} \text{---} \\ \cap \\ \text{---} \text{---} \end{array} + \begin{array}{c} \text{---} \text{---} \\ | \quad | \\ | \quad | \\ | \quad | \\ \text{---} \text{---} \end{array},$$

then the recursive formula of this lemma holds for  $n = 2$ . Now, we suppose by induction that (1.51) holds for  $n - 1$ , i.e., we suppose that

$$\begin{array}{c} \text{---} \text{---} \text{---} \text{---} \text{---} \\ | \quad | \quad | \quad | \quad | \\ \boxed{\mathbf{JW}_{n-1}} \\ | \quad | \quad | \quad | \quad | \\ \text{---} \text{---} \text{---} \text{---} \text{---} \end{array} = \begin{array}{c} \text{---} \text{---} \text{---} \text{---} \text{---} \\ | \quad | \quad | \quad | \quad | \\ \boxed{\mathbf{JW}_{n-2}} \\ | \quad | \quad | \quad | \quad | \\ \text{---} \text{---} \text{---} \text{---} \text{---} \end{array} + \sum_{j=1}^{n-2} \frac{j}{n-1} \begin{array}{c} \text{---} \text{---} \text{---} \text{---} \text{---} \\ | \quad | \quad | \quad | \quad | \\ \boxed{\mathbf{JW}_{n-2}} \\ | \quad | \quad | \quad | \quad | \\ \text{---} \text{---} \text{---} \text{---} \text{---} \\ \text{---} \text{---} \text{---} \text{---} \text{---} \\ | \quad | \quad | \quad | \quad | \\ \text{---} \text{---} \text{---} \text{---} \text{---} \end{array}. \tag{1.53}$$

So, for  $\mathbf{JW}_n$  we have

$$\begin{aligned}
\text{JW}_n &\stackrel{\text{def}}{=} \left[ \begin{array}{c} \dots \\ \text{JW}_{n-1} \\ \dots \end{array} \right] + \frac{n-1}{n} \left[ \begin{array}{c} \dots \\ \text{JW}_{n-1} \\ \dots \\ \text{JW}_{n-1} \\ \dots \end{array} \right] \\
&\stackrel{(1.53)}{=} \left[ \begin{array}{c} \dots \\ \text{JW}_{n-1} \\ \dots \end{array} \right] + \frac{n-1}{n} \left( \left[ \begin{array}{c} \dots \\ \text{JW}_{n-2} \\ \dots \\ \text{JW}_{n-1} \\ \dots \end{array} \right] + \sum_{j=1}^{n-2} \frac{j}{n-1} \left[ \begin{array}{c} \dots \\ \text{JW}_{n-2} \\ \dots \\ \text{JW}_{n-1} \\ \dots \end{array} \right] \right) \\
&\stackrel{\text{Lemma 1.3.8}}{=} \left[ \begin{array}{c} \dots \\ \text{JW}_{n-1} \\ \dots \end{array} \right] + \frac{n-1}{n} \left( \left[ \begin{array}{c} \dots \\ \text{JW}_{n-1} \\ \dots \end{array} \right] + \sum_{j=1}^{n-2} \frac{j}{n-1} \left[ \begin{array}{c} \dots \\ \text{JW}_{n-1} \\ \dots \end{array} \right] \right) \\
&= \left[ \begin{array}{c} \dots \\ \text{JW}_{n-1} \\ \dots \end{array} \right] + \frac{n-1}{n} \left( \sum_{j=1}^{n-1} \frac{j}{n-1} \left[ \begin{array}{c} \dots \\ \text{JW}_{n-1} \\ \dots \end{array} \right] \right) \\
&= \left[ \begin{array}{c} \dots \\ \text{JW}_{n-1} \\ \dots \end{array} \right] + \sum_{j=1}^{n-1} \frac{j}{n} \left[ \begin{array}{c} \dots \\ \text{JW}_{n-1} \\ \dots \end{array} \right],
\end{aligned}$$

and by induction the proof is finished.  $\square$

#### 4. Soergel Calculus

To any Coxeter system  $(W, S)$ , Elias and Williamson associated in [11], a diagrammatic category  $\mathcal{D}_{(W, S)}$ . We fix  $S := \{s, t\}$  and let  $W$  be the Coxeter group on  $S$  given by

$$W := \langle s, t \mid s^2 = t^2 = e \rangle \quad (1.54)$$

that is,  $W$  is the affine Weyl group of type  $\tilde{A}_1$ , or the infinite dihedral group with Bruhat order  $<$  chosen such that 1 is the minimal element. The definition of  $\mathcal{D}_{(W, S)}$  depends on the choice of a *realization*  $\mathfrak{h}$  of  $(W, S)$ , which is a representation  $\mathfrak{h}$  of  $W$  over  $\mathbb{C}$ , arising from a choice of *simple roots* and *simple coroots*, see [11, Section 3.1]. In [33], the realization  $\mathfrak{h}$  was chosen to be the *geometric representation* of  $W$  defined over  $\mathbb{C}$ , see [21, Section 5.3], with coroots  $\alpha_s^\vee, \alpha_t^\vee$  being a basis for  $\mathfrak{h}$  and roots  $\alpha_s, \alpha_t \in \mathfrak{h}^*$  given by

$$\alpha_s(\alpha_s^\vee) = 2, \quad \alpha_t(\alpha_s^\vee) = -2, \quad \alpha_s(\alpha_t^\vee) = -2, \quad \alpha_t(\alpha_t^\vee) = 2 \quad (1.55)$$

that is  $\alpha_s = -\alpha_t$ . With this choice of realization of  $(W, S)$ , the symmetric algebra of the dual representation is  $R := S(\mathfrak{h}^*) = \mathbb{C}[\alpha_s]$ , or simply a one-variable polynomial algebra.

In this thesis, we choose for realization  $\mathfrak{h}$  of  $(W, S)$  the *dual* of the geometric representation. To be precise, we choose  $\mathfrak{h}$  to be the  $\mathbb{C}$ -vector space of dimension two, containing an element  $\alpha_s^\vee = -\alpha_t^\vee$ , such that for a basis

$\alpha_s, \alpha_t$  for  $\mathfrak{h}^*$  the relations (1.55) hold. For this choice of  $\mathfrak{h}$  we have that

$$R = S(\mathfrak{h}^*) = \mathbb{C}[\alpha_s, \alpha_t] \quad (1.56)$$

that is  $R$  is a two-variable polynomial algebra.

We consider  $R$  to be a  $\mathbb{Z}$ -graded algebra where  $\deg(\alpha_s) = \deg(\alpha_t) = 2$ . The action of  $W$  on  $\mathfrak{h}^*$  is given by the formulas

$$s\alpha_s = -\alpha_s, \quad s\alpha_t = \alpha_t + 2\alpha_s, \quad t\alpha_t = -\alpha_t, \quad t\alpha_s = \alpha_s + 2\alpha_t. \quad (1.57)$$

It extends to an action of  $W$  on  $R$  and so we have the *Demazure operators*  $\partial_s, \partial_t : R \rightarrow R$  defined by:

$$\partial_s(f) = \frac{f - sf}{\alpha_s}, \quad \partial_t(f) = \frac{f - tf}{\alpha_t}. \quad (1.58)$$

We have that

$$\partial_s(\alpha_s) = \partial_t(\alpha_t) = 2, \quad \partial_s(\alpha_t) = \partial_t(\alpha_s) = -2. \quad (1.59)$$

Let us now briefly explain the definition of the diagrammatic Soergel category  $\mathcal{D}_{(W,S)}$  for our choices. Let  $\mathbf{exp}$  be the set of *expressions* over  $S$ , that is *words*  $\underline{w} = s_{i_1} s_{i_2} \cdots s_{i_n}$  in the alphabet  $S$ . We consider the empty expression  $\underline{w} = \emptyset$  to be an element of  $\mathbf{exp}$ .

DEFINITION 1.4.1. *Let  $(W, S)$  be as above. A Soergel diagram for  $(W, S)$  is a finite graph embedded in  $\mathbb{R} \times [0, 1]$ . The arcs of a Soergel diagram are coloured by either colour *red* or colour *blue*, corresponding to the elements of  $S$ . The vertices of a Soergel diagram are of the four possible types indicated below, univalent vertices (dots) and trivalent vertices where all three incident arcs are of the same colour.*



$$\text{red dot}, \quad \text{blue dot}, \quad \text{red trivalent}, \quad \text{blue trivalent}. \quad (1.60)$$

A Soergel diagram has its *regions*, that is the connected components of the complement of the graph in  $\mathbb{R} \times [0, 1]$ , decorated by elements of  $R$ . For simplicity, we omit the decoration  $1 \in R$  when drawing Soergel diagrams.

A vertex of an arc of a Soergel diagram that belongs to the boundary of the strip  $\mathbb{R} \times [0, 1]$  is called a *boundary point*. We say that an arc  $l$  of  $D$  is a *boundary dot arc* if one of its vertices is a dot and the other one is a boundary point. The left to right reading of the boundary points gives rise to two elements of  $\mathbf{exp}$  called the *bottom boundary* and *top boundary* of the diagram, respectively.

DEFINITION 1.4.2. *The diagrammatic Soergel category  $\mathcal{D}_{(W,S)}$  is the monoidal category whose objects are the elements of  $\mathbf{exp}$  and whose morphisms  $\text{Hom}_{\mathcal{D}}(\underline{x}, \underline{y})$  are the  $R$ -modules generated by all Soergel diagrams with bottom boundary  $\underline{x}$  and top boundary  $\underline{y}$ , modulo isotopy and modulo the following local relations*



$$\text{red dot on line} = \text{vertical line} \quad (1.61)$$



$$\text{red trivalent with horizontal} = \text{red trivalent with vertical} \quad (1.62)$$



$$\text{red dot on line} = \alpha_s \quad (1.63)$$

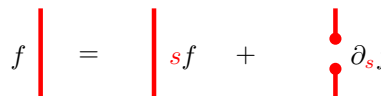

$$f \text{ on line} = \text{line with dot on right} + \text{line with dot on left} \quad (1.64)$$

$$\begin{array}{c} | \\ \bigcirc \\ | \end{array} = 0 \quad (1.65)$$

where the relations (1.61)–(1.65) also hold if red is replaced by blue.

For  $f \in R$  and  $D$  a Soergel diagram, the product  $fD$  is defined as the diagram obtained from  $D$  by replacing the polynomial  $g$  of the leftmost region of  $D$  by  $fg$ . The multiplication  $D_1D_2$  of diagrams  $D_1$  and  $D_2$  is given by vertical concatenation with  $D_2$  on top of  $D_1$ , where regions containing two polynomials are replaced by the same regions, but containing the product of these polynomials. The monoidal structure is given by horizontal concatenation. There is a natural  $\mathbb{Z}$ -grading on  $\mathcal{D}_{(W,S)}$ , extending the grading on  $R$ , in which dots, that is the first two diagrams in (1.60) have degree 1, and the trivalents, that is the last two diagrams in (1.60), have degree  $-1$ .

REMARK 1.4.3. For more details concerning the definition of  $\mathcal{D}_{(W,S)}$  one should consult [33] or the original paper [11]. Note that apart from the choice of realization of  $(W, S)$ , the relations appearing in Definition (1.4.2) also differ slightly from the ones appearing in the corresponding Definition 3.2 in [33]. To be precise, in Definition 3.2 of [33], there is a final relation

$$f \begin{array}{|c|} \hline D \\ \hline \end{array} = 0 \quad (1.66)$$

where  $D$  is any Soergel diagram and  $f$  is any homogeneous polynomial of strictly positive degree, multiplied on the left on  $D$ .

DEFINITION 1.4.4. We define  $\mathcal{D}_{(W,S)}^{\mathbb{C}}$  to be the category obtained from  $\mathcal{D}_{(W,S)}$  by adding relation (1.66).

REMARK 1.4.5. It is shown in [11] that there is an equivalence between  $\mathcal{D}_{(W,S)}$  and the category of Soergel bimodules for  $(W, S)$ . It induces an equivalence between  $\mathcal{D}_{(W,S)}^{\mathbb{C}}$  and the category of Soergel modules.

Let now  $n$  be a fixed non-negative integer and define  $\underline{w} \in \mathbf{exp}$  of length  $n$  via

$$\underline{w} := sts \cdots \quad (1.67)$$

such that the first generator of  $\underline{w}$  is  $s$  but the last generator depends on the parity of  $n$ . We then introduce  $\tilde{A}_{\underline{w}}$  as follows

$$\tilde{A}_{\underline{w}} := \text{End}_{\mathcal{D}_{(W,S)}}(\underline{w}). \quad (1.68)$$

By the definitions,  $\tilde{A}_{\underline{w}}$  is an  $R$ -algebra with multiplication  $D_1D_2$  given by concatenation of  $D_1$  and  $D_2$  and scalar product  $fD$  by multiplication of  $f$  with the polynomial appearing in the leftmost region of  $D$ . Its one-element is denoted 1, and is as follows

$$1 := \begin{array}{c} 1 \quad 2 \quad 3 \quad \dots \quad \dots \quad n \\ | \quad | \quad | \quad \dots \quad \dots \quad | \quad | \quad | \\ \dots \quad \dots \quad \dots \quad \dots \quad \dots \quad \dots \quad \dots \quad \dots \end{array} \quad (1.69)$$

For general  $(W, S)$  there is a, somewhat unwieldy, recursive procedure for constructing an  $R$ -basis for the morphisms  $\text{Hom}_{\mathcal{D}}(\underline{x}, \underline{y})$ , for any  $\underline{x}, \underline{y} \in \mathbf{exp}$ . It is a diagrammatic version of Libedinsky's *double leaves basis* for Soergel bimodules defined for the first time in [30], and the basis elements are also called double leaves. The double leaves basis was used, for example, to calculate counterexamples for the *Lusztig's conjecture*, see [31] and [47]. This fact is an example to show the importance of this concept. Now, returning to our context, for  $W$  the infinite dihedral group, there is however a non-recursive description of the double leaves basis that was shown in [29] and also was used extensively in [33], and that plays an important role in the present thesis.

The double leaves diagram basis elements for  $\tilde{A}_{\underline{w}}$  are built up from top and bottom 'half-diagrams', similarly to Temperley-Lieb and blob diagrams. Let us explain these half-diagrams, called *light leaves*, and their non-recursive description in order to describe the *double leaves basis*. For this, we need to introduce some combinatorial concepts and notations related to subexpressions used in [44] but slightly modified for our selection of  $W$ .



Continuing with  $\underline{w}$  fixed in (2.21), we define, for all  $1 \leq j \leq n$  the element of  $\mathbf{exp}$  give by

$$\underline{w}^j = \underbrace{st \cdots s}_j, \quad \text{generators}$$

where  $s = s$  if  $j$  is odd and  $s = t$  if  $j$  is even, and where we consider the initial case  $\underline{w}^0 = 1$ . Also we fix a binary sequence  $\mathbf{e} = (e_1, e_2, \dots, e_n)$ , that is,  $e_i \in \{0, 1\}$  for each  $1 \leq i \leq n$ , and we define  $\mathbf{e}^j := (e_1, e_2, \dots, e_j)$  for each  $1 \leq j \leq n$ . Additionally, for each  $j \in \{1, 2, \dots, n\}$  we define

$$\underline{w}^{\mathbf{e},j} = s^{e_1} t^{e_2} s^{e_3} \cdots s^{e_j} \in \mathbf{exp}$$

and

$$w^{\mathbf{e},j} = s^{e_1} t^{e_2} s^{e_3} \cdots s^{e_j} \in W,$$

where the last generator in both cases is, again,  $s = s$  if  $j$  is odd and  $s = t$  if  $j$  is even. Also we consider the initial cases

$$\underline{w}^{\mathbf{e},0} = 1 \text{ and } w^{\mathbf{e},0} = 1.$$

For example, if  $w = ststs$  and  $\mathbf{e} = (1, 0, 1, 1, 1)$  then we have the following elements using the above notation:

$j$	$\underline{w}^{\mathbf{e},j}$	$w^{\mathbf{e},j}$
0	1	1
1	$s^1$	$s$
2	$s^1 t^0$	$s$
3	$s^1 t^0 s^1$	1
4	$s^1 t^0 s^1 t^1$	$t$
5	$s^1 t^0 s^1 t^1 s^1$	$ts$

Now, the pair  $(\underline{w}, \mathbf{e})$  gives rise a sequence of  $n$  symbols  $T = (t_1, t_2, \dots, t_n)$  defined by the following rule:

$$t_j = \begin{cases} U & \text{if } w^{\mathbf{e},j-1} s_j > w^{\mathbf{e},j-1} \\ D & \text{otherwise.} \end{cases} \quad (1.70)$$

where  $s_j$  is the  $j$ -th generator of  $\underline{w}$ , that is,  $s_j = s$  if  $j$  is odd and  $s_j = t$  if  $j$  is even.

With the sequences  $T$  and  $\mathbf{e}$  we define the *label sequence*  $M_{\underline{w}, \mathbf{e}} = \{m_1, m_2, \dots, m_n\}$  by concatenating the symbols of  $T$  and  $\mathbf{e}$ , that is,  $m_j = t_j e_j$  for each  $1 \leq j \leq n$ . For example, if we consider the previous example with  $w = ststs$  and  $\mathbf{e} = (1, 0, 1, 1, 1)$  then we have the following table for the label sequence  $M_{\underline{w}, \mathbf{e}}$ :

$j$	$w^{\mathbf{e},j-1}$	$w^{\mathbf{e},j-1} s_j$	$t_j$	$e_j$
1	1	$s$	$U$	1
2	$s^1 = s$	$st$	$U$	0
3	$s^1 t^0 = s$	1	$D$	1
4	$s^1 t^0 s^1 = 1$	$t$	$U$	1
5	$s^1 t^0 s^1 t^1 = t$	$ts$	$U$	1

So, in this example we have that  $M_{\underline{w}, \mathbf{e}} = (U1, U0, D1, U1, U1)$ .

With this notation, we construct a sequence of morphisms  $\mathbb{L}_{\underline{w}, \mathbf{e}, j} \in \text{Hom}_{\mathcal{D}}(\underline{w}^j, w^{\mathbf{e}, j})$ . This is the diagrammatic construction of *light leaves* developed in [11] for general coxeter systems, but in this thesis we only need this construction for  $W$  the infinite dihedral group, so, our construction is a particular case of the original diagrammatic construction of *light leaves*. We first let  $\mathbb{L}_{\underline{w}, \mathbf{e}, 0}$  be the empty diagram. The hypothesis is to suppose recursively that  $\mathbb{L}_{\underline{w}, \mathbf{e}, j-1}$  has already been constructed. Now, and without loss of generality, we suppose that the last generator of  $\underline{w}$  is  $t$  ( $j$  even). The,  $\mathbb{L}_{\underline{w}, \mathbf{e}, j}$  is obtained from  $\mathbb{L}_{\underline{w}, \mathbf{e}, j-1}$  by first adding on the right a vertical arc of colour blue. This arc only depends on the value of  $m_j$ . There are four cases to consider:

- If  $m_j = U0$  then the new arc is terminated with a blue dot. In other words,  $\mathbb{L}_{\underline{w}, \mathbf{e}, j}$  is the diagram  $\mathbb{L}_{\underline{w}, \mathbf{e}, j-1}$  with an extra blue dot on the right.

- If  $m_j = U1$  then the new arc is a propagating blue line. In other words,  $\mathbb{L}\underline{w},\mathbf{e},j$  is the diagram  $\mathbb{L}\underline{w},\mathbf{e},j-1$  with an extra propagating blue line on the right.
- If  $m_j = D0$  then the new arc is a trivalent vertex. In this case, this trivalent vertex is applied to the rightmost propagating line of  $\mathbb{L}\underline{w},\mathbf{e},j-1$  which is of colour blue, and the right of  $\mathbb{L}\underline{w},\mathbf{e},j-1$ , adding a new blue line.
- If  $m_j = D1$  the we proceed as in case  $D0$ , replacing the blue trivalent vertex with a blue cap.

The diagrammatic representation of these four case are the following:

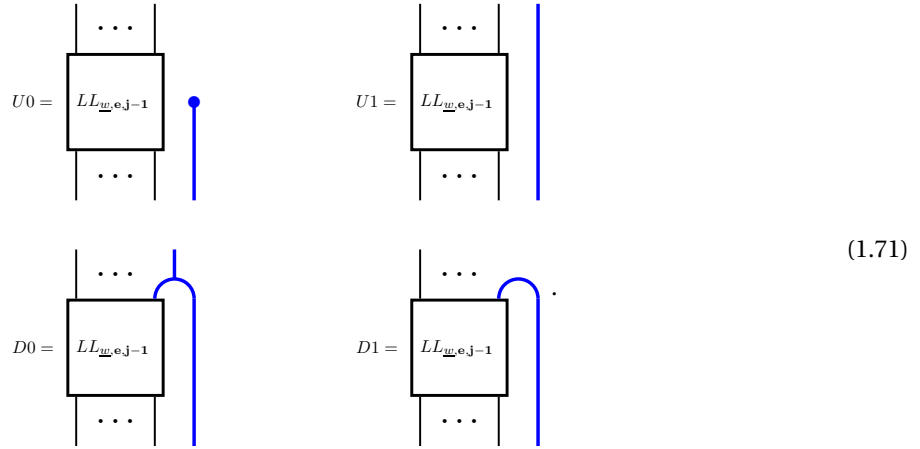

So, in each step of this recursion, we call *light leaf morphism associated to the pair  $(\underline{w}^j, \mathbf{e}^j)$*  to the diagram  $\mathbb{L}\underline{w},\mathbf{e},j$ . In particular, we set  $\mathbb{L}\underline{w},\mathbf{e} := \mathbb{L}\underline{w},\mathbf{e},n$  as the *light leaf morphism associated to  $\underline{w}$  and  $\mathbf{e}$* .

For example, taking again  $w = ststs$  and  $\mathbf{e} = (1, 0, 1, 1, 1)$ , with label sequence  $M_{\underline{w},\mathbf{e}} = (U1, U0, D1, U1, U1)$ , we have the following light leaves sequence:

$j$	$\mathbb{L}\underline{w},\mathbf{e},j-1$	$m_j$	New arc to add	$\mathbb{L}\underline{w},\mathbf{e},j$
1	Empty diagram	$U1$		
2		$U0$		
3		$D1$		
4		$U1$		
5		$U1$		

The previous example show the recursive construction of light leaves for a pair  $(\underline{w}, \mathbf{e})$ . This procedure implies a non-recursive construction for the light leaves, but this requires explaining other diagrams.

By the isotopy relations for Soergel diagrams, we have the following diagram identities

(1.72)

and we in shall in general represent these diagrams as follows

(1.73)

The diagrams in (1.73) are called *hanging full birdcages*. We shall also consider *non-hanging full birdcages* that look as follows

(1.74)

We sometimes omit the word 'full' when referring to 'full birdcages'. We say that the birdcages in (1.72), (1.73) and (1.74) are of *colour blue*, but shall also allow birdcages of *colour red*, as follows

(1.75)

We further allow *degenerate*, non-hanging and hanging, full birdcages as follows

(1.76)

We define the *length* of a full birdcage to be the number of *enclosed* dots in it, where the birdcages of length zero are the degenerate ones. A full birdcage which is not degenerate is called *non-degenerate*. In the following examples, the first birdcage is of length 4 whereas the last two are of length zero.

(1.77)

We also consider *top full birdcages*, that are obtained from bottom full birdcages by reflecting through a horizontal axis.

We now introduce the operation of replacing a degenerate non-hanging full birdcage, in other words a boundary dot arc, by a non-hanging non-degenerate full birdcage as follows

(1.78)

In the notation of [29], a *birdcagecage* is any diagram that can be obtained by performing the above operation repeatedly a number of times, for example

(1.79)

With the recursive procedure for constructing a light leaf and the concepts of birdcages we have the following non-recursive structure for a light leaf construction.

LEMMA 1.4.6. Let  $\underline{w} = sts \cdots \in \mathbf{exp}$  of length  $n \in \mathbb{Z}^+ \cup \{0\}$  and let  $\mathbf{e} \in \{0, 1\}^n$ . Then the diagram for the light leaf morphism  $\mathbb{L}\mathbb{L}_{\underline{w}, \mathbf{e}, n}$  have the following structure:

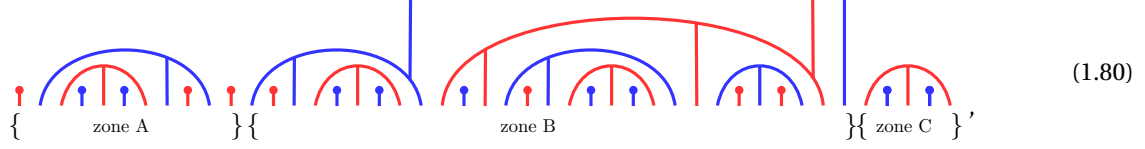

where the bottom boundary is  $\underline{w}$  and the top boundary is  $\underline{w}^{\mathbf{e}, n}$ . Zone A consists of a number of non-hanging birdcagecages whereas zone B consists of a number of hanging birdcagecages, but zone C may consist of at most one non-hanging birdcagecage. If  $n = 0$  then  $\mathbb{L}\mathbb{L}_{\underline{w}, \mathbf{e}, n}$  is the empty diagram.

*Proof:* By induction on  $n$ . If  $n = 0$  we have, by recursive construction, that  $\mathbb{L}\mathbb{L}_{\underline{w}, \mathbf{e}, 0}$  is the empty diagram. We suppose that  $\mathbb{L}\mathbb{L}_{\underline{w}, \mathbf{e}, n}$  has the structure as in (1.80). Now, we show that  $\mathbb{L}\mathbb{L}_{\underline{w}, \mathbf{e}, n+1}$  has the same structure.

Without loss of generality, we suppose that the last generator of  $\underline{w}$  is  $t$ , that is

$$\underline{w} = \underbrace{st \cdots t}_{n+1 \text{ letters}}$$

. The structure of  $\mathbb{L}\mathbb{L}_{\underline{w}, \mathbf{e}, n+1}$  depends of the last term  $m_{n+1}$  in the label sequence  $M_{\underline{w}, \mathbf{e}}$  and the structure of  $\mathbb{L}\mathbb{L}_{\underline{w}, \mathbf{e}, n}$ :

- If  $m_{n+1} = U0$  then  $w^{\mathbf{e}, n} t > w^{\mathbf{e}, n}$ . This implies that the last generator of  $w^{\mathbf{e}, n}$  and  $\underline{w}^{\mathbf{e}, n}$  is  $s$ , or  $w^{\mathbf{e}, n} = 1$ . So, if  $w^{\mathbf{e}, n} = s$ , and by hypothesis, since the diagram  $\mathbb{L}\mathbb{L}_{\underline{w}, \mathbf{e}, n}$  has the structure (1.80), then  $\mathbb{L}\mathbb{L}_{\underline{w}, \mathbf{e}, n}$  has in the rightmost a red hanging birdcagecage, and by recursive construction,  $\mathbb{L}\mathbb{L}_{\underline{w}, \mathbf{e}, n+1}$  is  $\mathbb{L}\mathbb{L}_{\underline{w}, \mathbf{e}, n}$  with an additional blue dot in the rightmost position, on the bottom boundary. Therefore,  $\mathbb{L}\mathbb{L}_{\underline{w}, \mathbf{e}, n+1}$  has the structure indicated in (1.80), where zone A and zone B are exactly the diagram  $\mathbb{L}\mathbb{L}_{\underline{w}, \mathbf{e}, n}$  and the zone C is the new blue dot. The second case is when  $w^{\mathbf{e}, n} = 1$ , which implies that  $\mathbb{L}\mathbb{L}_{\underline{w}, \mathbf{e}, n}$  has empty Zone B and C, and then  $\mathbb{L}\mathbb{L}_{\underline{w}, \mathbf{e}, n+1}$  is the diagram  $\mathbb{L}\mathbb{L}_{\underline{w}, \mathbf{e}, n}$  but with an additional blue dot on the rightmost position.
- If  $m_{n+1} = U1$  then we have the case  $m_{n+1} = U0$  but replacing the extra blue dot with a propagating blue line.
- If  $m_{n+1} = D0$  then  $w^{\mathbf{e}, n} t < w^{\mathbf{e}, n}$ . This implies that the last generator of  $w^{\mathbf{e}, n}$  and  $\underline{w}^{\mathbf{e}, n}$  is  $t$ . Therefore,  $\mathbb{L}\mathbb{L}_{\underline{w}, \mathbf{e}, n}$  is a diagram where the rightmost letter of its bottom boundary is  $s$  and the rightmost letter of its top boundary is  $t$ . This means that  $\mathbb{L}\mathbb{L}_{\underline{w}, \mathbf{e}, n}$  has in its zone B a hanging birdcagecage in its rightmost position, and also has a non-empty zone C, with a non-hanging red birdcagecage. So, by recursive construction,  $\mathbb{L}\mathbb{L}_{\underline{w}, \mathbf{e}, n+1}$  is the diagram  $\mathbb{L}\mathbb{L}_{\underline{w}, \mathbf{e}, n}$  with an extra blue trivalent which is connected with the rightmost hanging birdcagecage in the zone B of  $\mathbb{L}\mathbb{L}_{\underline{w}, \mathbf{e}, n}$  and on the right of the non-hanging red birdcagecage of  $\mathbb{L}\mathbb{L}_{\underline{w}, \mathbf{e}, n}$ , enclosing this non-hanging red birdcagecage. So,  $\mathbb{L}\mathbb{L}_{\underline{w}, \mathbf{e}, n+1}$  has the structure (1.80). In other words, in this case we have that

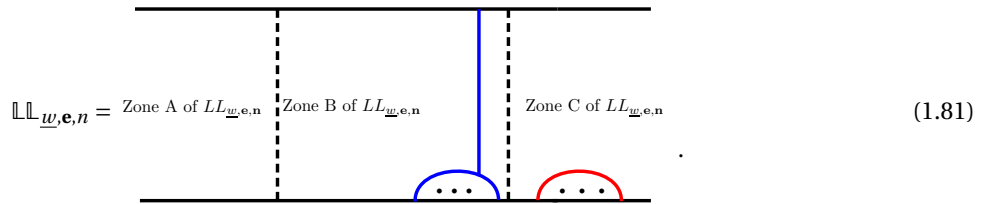

and

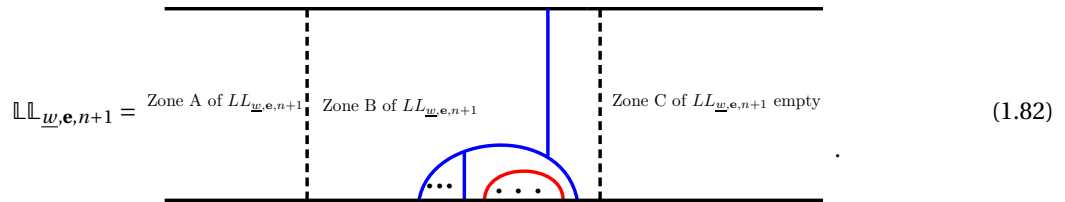

- If  $m_{n+1} = D1$  then we have the case  $m_{n+1} = D0$  but replacing the extra blue trivalent with a blue cap.

□

Now, with the previous non-recursive construction for light leaves we can define a non-recursive construction for double leaves. The hanging birdcagecages in zone B of a light leaves diagram define an element  $v \in W$ . In the above example we have  $v = tst$ . The *double leaves basis* of  $\tilde{A}_w$  is obtained by running over all  $v \leq w$  and over all pairs of light leaves for  $\tilde{A}_w$  that are associated with that  $v$ . For each such pair  $(D_1, D_2)$  the second component  $D_2$  is reflected through a horizontal axis, and the two components are glued together. The resulting diagram is a double leaf, for example

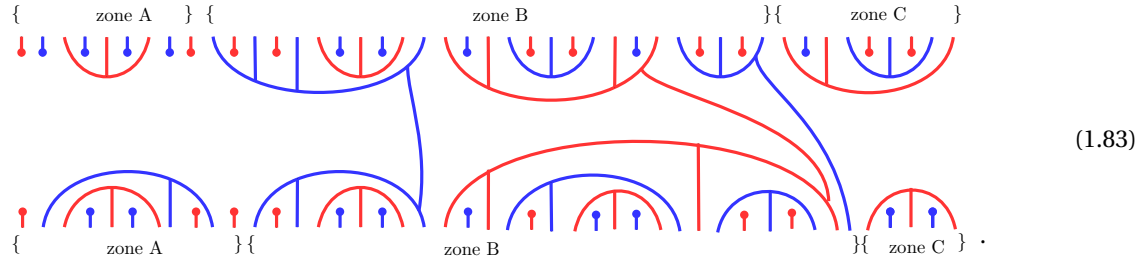

The fundamental result concerning double leaves is the fact that they form an  $R$ -basis for  $\tilde{A}_w$ . In fact, a stronger Theorem holds. Let  $\tilde{\Lambda}_w := \{v \in W \mid v \leq w\}$ , endowed with poset structure via the Bruhat order  $<$ . For  $v \in \tilde{\Lambda}_w$  let  $\text{Tab}_w(v)$  be the set of light leaves for  $\tilde{A}_w$  defining  $v$  in the above sense, and for  $D_1, D_2 \in \text{Tab}_w(v)$  let  $C_{D_1, D_2}^v \in \tilde{A}_w$  be the double leaf obtained by gluing as above. We now have the following Theorem.

**THEOREM 1.4.7.** *The triple  $(\tilde{\Lambda}_w, \text{Tab}_w(v), C)$  defines a cellular basis structure on  $\tilde{A}_w$ .*

*Proof:* See [29] and [11].

□

## Graded sum formula for $\tilde{A}_1$ -Soergel calculus and the nil-blob algebra

In this chapter we show the content of our work with my thesis advisor Steen Ryom-Hansen.

### 1. Blob algebras

Throughout we use as ground field the complex numbers  $\mathbb{C}$ , although several of our results hold in greater generality. We set

$$R := \mathbb{C}[x, y]. \quad (2.1)$$

We consider  $R$  to be a (non-negatively)  $\mathbb{Z}$ -graded  $\mathbb{C}$ -algebra via

$$\deg(x) = \deg(y) = 2. \quad (2.2)$$

The blob algebra was introduced by Martin and Saleur in [35], as a way of considering boundary conditions in the statistical mechanical model of the Temperley-Lieb algebra. Since its introduction, the blob algebra has been the subject of much research activity in mathematics as well as physics, see for example [14], [34], [36], [38], [39], [40], [41]. In this thesis, we shall use the following variation of it.

DEFINITION 2.1.1. *The two-parameter blob algebra  $\mathbb{B}_n^{x,y}$ , or more precisely the blob algebra with loop-parameter  $-2$ , marked loop parameter  $y$  and blob-parameter  $x$ , is the  $R$ -algebra on the generators  $\mathbb{U}_0, \mathbb{U}_1, \dots, \mathbb{U}_{n-1}$  subject to the relations*

$$\mathbb{U}_i^2 = -2\mathbb{U}_i \quad \text{if } 1 \leq i < n \quad (2.3)$$

$$\mathbb{U}_i \mathbb{U}_j \mathbb{U}_i = \mathbb{U}_i \quad \text{if } |i - j| = 1 \text{ and } i, j > 0 \quad (2.4)$$

$$\mathbb{U}_i \mathbb{U}_j = \mathbb{U}_j \mathbb{U}_i \quad \text{if } |i - j| > 1 \quad (2.5)$$

$$\mathbb{U}_1 \mathbb{U}_0 \mathbb{U}_1 = y \mathbb{U}_1 \quad (2.6)$$

$$\mathbb{U}_0^2 = x \mathbb{U}_0. \quad (2.7)$$

The nil-blob algebra  $\mathbb{N}\mathbb{B}_n$ , that was introduced and studied extensively in [33], may be recovered from  $\mathbb{B}_n^{x,y}$  via specialization, that is

$$\mathbb{N}\mathbb{B}_n \cong \mathbb{B}_n^{x,y} \otimes_R \mathbb{C} \quad (2.8)$$

where  $\mathbb{C}$  is made into an  $R$ -algebra via  $x \mapsto 0$  and  $y \mapsto 0$ . In other words,  $\mathbb{B}_n^{x,y}$  may be considered a deformation of  $\mathbb{N}\mathbb{B}_n$ , and in fact this shall be the point of view of the present thesis.

Another interesting specialization of  $\mathbb{B}_n^{x,y}$  is  $\tilde{\mathcal{T}}_n$  defined as  $\tilde{\mathcal{T}}_n := \mathbb{B}_n^{x,y} \otimes_R \mathbb{C}$  where  $\mathbb{C}$  is made into an  $R$ -algebra via  $x \mapsto 1$  and  $y \mapsto -2$ . Let  $\mathcal{I} := \langle \mathbb{U}_0 - 1 \rangle$  be the two-sided ideal in  $\tilde{\mathcal{T}}_n$  generated by  $\mathbb{U}_0 - 1$ . Then

$$\mathcal{T}_n := \tilde{\mathcal{T}}_n / \mathcal{I} \quad (2.9)$$

is the Temperley-Lieb algebra from Definition 1.2.6, but defined over  $\mathbb{C}$ .

Just as is the case for  $\mathbb{N}\mathbb{B}_n$ , one easily checks that  $\mathbb{B}_n^{x,y}$  is a  $\mathbb{Z}$ -graded algebra.

LEMMA 2.1.2. *The rules  $\deg(\mathbb{U}_i) = 0$  for  $i > 0$  and  $\deg(\mathbb{U}_0) = 2$  define a (non-negative)  $\mathbb{Z}$ -grading on  $\mathbb{B}_n^{x,y}$ .*

PROOF. The relations are easily seen to be homogeneous with respect to  $\deg$ .  $\square$

As already indicated in the preliminaries chapter,  $\mathbb{T}\mathbb{L}_n$  is a diagram algebra, but  $\mathbb{B}_n^{x,y}$  are also a diagram algebra. The diagram basis for  $\mathbb{B}_n^{x,y}$  consists of blobbed (marked) Temperley-Lieb diagrams on  $n$  points, or *blob diagrams* on  $n$  points, which are marked planar pairings between  $n$  northern points and  $n$  southern points of a rectangle, where only pairings exposed to the left side of the rectangle may be marked, and at most once. There is thus a natural embedding of Temperley-Lieb diagrams into blob diagrams. The multiplication  $D_1 D_2$  of two diagrams  $D_1$  and  $D_2$  is given by concatenation of them, with  $D_2$  on top of  $D_1$ . This concatenation process may

give rise to internal marked or unmarked loops, as well as diagrams with more than one mark. Internal unmarked loops are removed from a diagram by multiplying it by  $-2$ , whereas internal marked loops are removed from a diagram by multiplying it by  $y$ . Finally, any diagram with  $r > 1$  marks on a diagram is set equal to the same diagram multiplied by  $x^{r-1}$ , but with the  $(r-1)$  extra marks removed. For example, for

$$D_1 = \begin{array}{c} \text{diagram with 2 marks} \\ \text{diagram with 1 mark} \end{array}, \quad D_2 = \begin{array}{c} \text{diagram with 1 mark} \\ \text{diagram with 0 marks} \end{array} \quad (2.10)$$

we have that

$$D_1 D_2 = \begin{array}{c} \text{diagram with 2 marks} \\ \text{diagram with 1 mark} \\ \text{diagram with 0 marks} \end{array} = x^2 y \begin{array}{c} \text{diagram with 1 mark} \\ \text{diagram with 0 marks} \end{array}. \quad (2.11)$$

Later on, we shall give many more examples.

For the proof of the isomorphisms between  $\mathbb{B}_n^{x,y}$  and its diagrammatic version, one may consult the appendix of [9] or else adapt the more self-contained proof given in [33]. Under the isomorphism we have that

$$1 \mapsto \begin{array}{c} | \\ | \\ | \\ \dots \\ | \\ | \\ | \end{array} \quad (2.12)$$

and that

$$\cup_0 \mapsto \begin{array}{c} \bullet \\ | \\ | \\ | \\ \dots \\ | \\ | \\ | \end{array}, \quad \cup_i \mapsto \begin{array}{c} | \\ | \\ | \\ \dots \\ \cup \\ \dots \\ | \\ | \\ | \end{array}. \quad (2.13)$$

The number of Temperley-Lieb diagrams and blob diagrams on  $n$  points is the Catalan number  $\frac{1}{n+1} \binom{2n}{n}$  and  $\binom{2n}{n}$ . In particular  $\mathbb{T}\mathbb{L}_n$  and  $\mathbb{B}_n^{x,y}$  are free over  $R$  of rank

$$\text{rk } \mathbb{T}\mathbb{L}_n = \frac{1}{n+1} \binom{2n}{n} \text{ and } \text{rk } \mathbb{B}_n^{x,y} = \binom{2n}{n}. \quad (2.14)$$

From Theorem 1.2.7 we have that  $\mathbb{T}\mathbb{L}_n$  is a cellular algebra. This result also holds for  $\mathbb{B}_n^{x,y}$ . To make  $\mathbb{B}_n^{x,y}$  fit into the cellular algebra language we choose:

- $\mathbb{k} = R$
- $\Lambda = \{\Lambda_{\pm n} := \{\pm n, \pm(n-2), \dots, \pm 1\}$  (or  $\Lambda := \Lambda_{\pm n} = \{\pm n, \pm(n-2), \dots, \pm 2, 0\}$ ) if  $n$  is odd (or even), with poset structure given by  $\lambda < \mu$  if  $|\lambda| < |\mu|$  or if  $|\lambda| = |\mu|$  and  $\lambda < \mu$ . For example, for  $n = 6$  we have

$$\Lambda_{\pm 6} := \{\pm 6, \pm 4, \pm 2, 0\}, \quad 0 < -2 < 2 < -4 < 4 < -6 < 6 \quad (2.15)$$

- For  $\lambda \in \Lambda_{\pm n}$  we choose  $\text{Tab}(\lambda)$  to be blob *half-diagrams* with  $|\lambda|$  *propagating* lines, that is marked Temperley-Lieb diagrams on  $|\lambda|$  northern and  $n$  southern points in which each northern point is paired with a southern point and in which only non-propagating pairings exposed to the left side of the rectangle may be marked.
- For  $s, t \in \text{Tab}(\lambda)$  we define  $C_{st}^\lambda$  to be the diagram obtained from gluing  $s$  and the horizontal reflection of  $t$ , with  $s$  on the bottom, and marking the leftmost propagating line if  $\lambda < 0$ . Here is an example of this gluing process with  $n = 8$  and  $s, t \in \text{Tab}(-2)$ .

$$(s, t) = \left( \begin{array}{c} \text{diagram } s \\ \text{diagram } t \end{array} \right) \mapsto \begin{array}{c} \text{glued diagram} \end{array}. \quad (2.16)$$

With this notation we have the following Theorem.

THEOREM 2.1.3. *The above triple  $(\Lambda_{\pm n}, \text{Tab}, C)$  makes  $\mathbb{B}_n^{x,y}$  into a cellular algebra.*

*Proof:* This also follows directly from the definitions.  $\square$

For  $\lambda \in \Lambda_n$  or for  $\lambda \in \Lambda_{\pm n}$  we define  $t_\lambda \in \text{Tab}(\lambda)$  to be the following half-diagram

$$t_\lambda = \begin{array}{c} \frown \quad \frown \quad \dots \quad \frown \quad \parallel \quad \parallel \quad \dots \quad \parallel \\ 1 \quad 2 \quad \quad \quad k \quad 1 \quad 2 \quad \quad \quad |\lambda| \end{array} \quad (2.17)$$

and set  $C_\lambda = C_{t_\lambda}^\lambda$ , that is

$$C_\lambda = \begin{cases} \cup_1 \cup_3 \dots \cup_{2k-1} = \begin{array}{c} \smile \quad \smile \quad \dots \quad \smile \quad \parallel \quad \parallel \quad \dots \quad \parallel \\ 1 \quad 2 \quad \quad \quad k \quad 1 \quad 2 \quad \quad \quad |\lambda| \end{array} & \text{if } \lambda \geq 0 \\ (\cup_1 \cup_3 \dots \cup_{2k-1}) \cup_0 (\cup_2 \cup_4 \dots \cup_{2k}) \cup_1 \cup_3 \dots \cup_{2k-1} = \begin{array}{c} \smile \quad \smile \quad \dots \quad \smile \quad \parallel \quad \parallel \quad \dots \quad \parallel \\ 1 \quad 2 \quad \quad \quad k \quad 1 \quad 2 \quad \quad \quad |\lambda| \end{array} & \text{if } \lambda < 0 \end{cases} \quad (2.18)$$

where  $k = (n - |\lambda|)/2$ . Thus  $C_\lambda$  is an element of  $\mathbb{T}\mathbb{L}_n$  or  $\mathbb{B}_n^{x,y}$ , depending on the context. With this we can define the two-sided *cell* ideals  $A^\lambda$  and  $A^{<\lambda}$  of  $\mathbb{T}\mathbb{L}_n$  (resp.  $\mathbb{B}_n^{x,y}$ ) via

$$A^\lambda := \{aC_\lambda b \mid a, b \in \mathbb{T}\mathbb{L}_n \text{ (resp. } \mathbb{B}_n^{x,y})\} \text{ and } A^{<\lambda} := \{aC_\mu b \mid a, b \in \mathbb{B}_n^{x,y} \text{ (resp. } \mathbb{B}_n^{x,y}) \text{ and } \mu < \lambda\}. \quad (2.19)$$

It follows from Definition 1.2.1 that  $A^{<\lambda} \subset A^\lambda$  and so  $A^\lambda/A^{<\lambda}$  is a  $\mathbb{T}\mathbb{L}_n$ -bimodule (resp.  $\mathbb{B}_n^{x,y}$ -bimodule). Let  $\overline{C}_\lambda := C_\lambda + A^{<\lambda}$ . We define the *cell module*  $\Delta_n^{\mathbb{T}\mathbb{L}}(\lambda)$  for  $\mathbb{T}\mathbb{L}_n$  (resp.  $\Delta_n^{\mathbb{B}}(\lambda)$  for  $\mathbb{B}_n^{x,y}$ ) as

$$\Delta_n^{\mathbb{T}\mathbb{L}}(\lambda) := \mathbb{T}\mathbb{L}_n \overline{C}_\lambda \text{ (resp. } \Delta_n^{\mathbb{B}}(\lambda) := \mathbb{B}_n^{x,y} \overline{C}_\lambda) \subseteq A^\lambda/A^{<\lambda}. \quad (2.20)$$

We now have the following Theorem.

THEOREM 2.1.4. *Let  $\Delta_n^{\mathbb{T}\mathbb{L}}(\lambda)$  be the cell module for  $\mathbb{T}\mathbb{L}_n$ . Then  $\Delta_n^{\mathbb{T}\mathbb{L}}(\lambda)$  is free over  $R$  with basis  $\{\overline{C}_{st_\lambda} \mid s \in \text{Tab}(\lambda)\}$  where  $\overline{C}_{st_\lambda} := C_{st_\lambda} + A^{<\lambda}$ . A similar statement holds for  $\Delta_n^{\mathbb{B}}(\lambda)$ .*

*Proof:* This follows from the algorithm given in the proof Theorem 2.5 of [33].  $\square$

REMARK 2.1.5. Our definition (2.20) of the cell modules for  $\mathbb{T}\mathbb{L}_n$  and  $\mathbb{B}_n^{x,y}$  differs slightly from the definition given in [15] or the Definition 1.2.2, but in view of the Theorem the definitions coincide.

## 2. Isomorphism Theorems

We now come to Soergel calculus. In [33], an isomorphism  $A_w \cong \mathbb{N}\mathbb{B}_n$  was established, where  $A_w$  is the endomorphism algebra of a Bott-Samelson object in the Soergel calculus of type  $\tilde{A}_1$ . We aim at generalizing this result to an isomorphism involving  $\mathbb{B}_n^{x,y}$ .

As in the preliminaries chapter, let now  $n$  be a fixed non-negative integer and define  $\underline{w} \in \mathbf{exp}$  of length  $n$  via

$$\underline{w} := st_s \dots \quad (2.21)$$

such that the first generator of  $\underline{w}$  is  $s$  but the last generator depends on the parity of  $n$ , and

$$\tilde{A}_w := \text{End}_{\mathcal{D}_{(w,s)}}(\underline{w}), \quad (2.22)$$

where  $\mathcal{D}_{(w,s)}$  is the diagrammatic Soergel category of Definition (1.4.2).

As in [33] we introduce certain elements of  $\tilde{A}_w$  that shall play a key role throughout. For  $i = 1, \dots, n-2$ , let  $U_i$  be the following element of  $\tilde{A}_w$

$$U_i := \begin{array}{c} 1 \quad 2 \quad 3 \quad \quad \quad i \quad \quad \quad \quad \quad n \\ \parallel \quad \parallel \quad \parallel \quad \quad \quad \smile \quad \smile \quad \quad \quad \parallel \quad \parallel \quad \parallel \\ \vdots \quad \vdots \quad \vdots \quad \quad \quad \vdots \quad \quad \quad \quad \quad \vdots \quad \vdots \quad \vdots \\ \parallel \quad \parallel \quad \parallel \quad \quad \quad \smile \quad \smile \quad \quad \quad \parallel \quad \parallel \quad \parallel \\ \vdots \quad \vdots \quad \vdots \quad \quad \quad \vdots \quad \quad \quad \quad \quad \vdots \quad \vdots \quad \vdots \end{array} \quad (2.23)$$



and for  $i = 0$ , set

$$U_0 := \begin{array}{cccc} 1 & 2 & 3 & n \\ \begin{array}{c} | \\ | \\ \bullet \\ | \\ \bullet \\ | \\ | \end{array} & \begin{array}{c} | \\ | \\ | \\ | \end{array} & \begin{array}{c} | \\ | \\ | \\ | \end{array} & \begin{array}{c} | \\ | \\ | \\ | \end{array} \\ \dots & & & \dots \end{array} \quad (2.24)$$

The following Theorem is fundamental for this thesis.

**THEOREM 2.2.1.** *There is a homomorphism of  $R$ -algebras  $\varphi: \mathbb{B}_{n-1}^{x,y} \rightarrow \tilde{A}_w$  given by  $\cup_i \mapsto U_i$  for  $i = 0, 1, \dots, n-2$ .*

*Proof:* The proof is almost identical to the proof of Theorem 3.4 in [33]. We must check that  $U_0, U_1, \dots, U_{n-2}$  satisfy the relations given by the  $\cup_i$ 's in Definition (2.1.1). The verification of the relations (2.3), (2.4) and (2.5) is done exactly as in [33] whereas relation (2.6), for example for  $n = 4$ , is verified as follows

$$U_1 U_0 U_1 = \begin{array}{c} \cup \\ | \\ \cup \\ | \\ \cup \end{array} = \begin{array}{c} \cup \\ | \\ \cup \\ | \\ \cup \end{array} = \alpha_t = y U_1 \quad (2.25)$$

and (2.7), for example for  $n = 4$ , is verified as follows

$$U_0^2 = \begin{array}{c} | \\ | \\ | \\ | \end{array} = \alpha_t = x U_0. \quad (2.26)$$

This proves the Theorem.  $\square$

Following [33], we now introduce  $A_w \subseteq \tilde{A}_w$  as follows.

**DEFINITION 2.2.2.** *Let  $A_w$  be the span in  $\tilde{A}_w$  of all double leaves with empty zone  $C$ , or equivalently,  $A_w$  is the free  $R$ -module with basis given by the double leaves of empty zone  $C$ .*

Our next Theorem is an analogue of Theorem 3.8 and Corollary 3.9 of [33], although the proofs of parts **b**) and **c**) of the Theorem are different from the proofs of the corresponding statements in [33], since the algebras considered in [33] are  $\mathbb{C}$ -algebras whereas the algebras in the present thesis are  $R$ -algebras. Therefore, in the present article some extra care is necessary since nonzero coefficients of  $R$  need not be invertible. Moreover, the arguments in [33] depend on the linear algebra fact that injective linear transformations  $f: V \rightarrow W$  between vector spaces  $V$  and  $W$  of the same finite dimension are isomorphisms. The analogous statement is false for free  $R$ -modules, which is the main reason why the proofs of the present thesis are different from the ones in [33].

**THEOREM 2.2.3.**

- The cardinality of double leaves of empty zone  $C$  is  $\binom{2n}{n}$  and so  $A_w$  is free over  $R$  of rank  $\text{rk } A_w = \text{rk } \mathbb{B}_n^{x,y} = \binom{2n}{n}$ .
- $A_w$  is an  $R$ -algebra. It is the subalgebra of  $\tilde{A}_w$  generated by  $U_0, U_1, \dots, U_{n-2}$ .
- The homomorphism  $\varphi: \mathbb{B}_{n-1}^{x,y} \rightarrow \tilde{A}_w$  from Theorem 2.2.1 induces an isomorphism  $\varphi: \mathbb{B}_{n-1}^{x,y} \rightarrow A_w$ .

*Proof:* To show a) we first note that the cardinality of the set of double leaves of empty zone  $C$  is given by Definition 3.7 in [33] and Theorem 3.8 c) in [33], and so the statements about  $A_w$  are a direct consequence of Definition 2.2.2 and (2.14).

In order to prove b) we define  $A'_w$  to be the subalgebra of  $\tilde{A}_w$  generated by  $U_0, U_1, \dots, U_{n-2}$  and must show that  $A'_w = A_w$ . We first show that  $A'_w \supseteq A_w$ .

Recall the diagram  $C_\lambda \in \mathbb{B}_n^{x,y}$  from (2.18). For  $\lambda \geq 0$  we have that

$$\varphi(C_\lambda) = U_1 U_3 \cdots U_{2k-1} = \begin{array}{c} \text{Diagram with red and blue arcs and vertical lines} \\ \text{Labels: } 1, 2, \dots, 2k+1, \dots, n \end{array} \quad (2.27)$$

and for  $\lambda < 0$  we have

$$\varphi(C_\lambda) = (U_1 U_3 \cdots U_{2k-1}) U_0 (U_2 U_4 \cdots U_{2k}) U_1 U_3 \cdots U_{2k-1} = \begin{array}{c} \text{Diagram with red and blue arcs and vertical lines} \\ \text{Labels: } 1, 2, \dots, 2k+1, \dots, n \end{array} = \begin{array}{c} \text{Diagram with red and blue arcs and vertical lines} \\ \text{Labels: } 1, 2, \dots, 2k+1, \dots, n \end{array} \quad (2.28)$$

We also need the diagrams

$$\varphi(U_i U_{i+2} \cdots U_{i+2k}) = \begin{array}{c} \text{Diagram with red and blue arcs and vertical lines} \\ \text{Labels: } i, i+2+2k, \dots, n \end{array} \quad (2.29)$$

Now, multiplying together appropriate diagrams of the form (2.27) and of the form (2.28) we deduce that any diagram of the form

$$\begin{array}{c} \text{Diagram with red and blue arcs and vertical lines} \\ \text{Labels: } 1, 2, \dots, 2k+1, \dots, n \end{array} \quad (2.30)$$

belongs to  $A'_w$  where the number of hanging birdcages on the right is at least one. The number of non-hanging birdcages on top of (2.30) is the same as on the bottom, but we need to break this symmetry, that is, we must show that diagrams  $D$  as in (2.30), but with unequal numbers of top and bottom non-hanging birdcages in zone A, also belong to  $A'_w$ . Note that the number of top and the number of bottom non-hanging birdcages in zone A are always of the same parity and so, in order to break this symmetry in zone A, we first give a procedure for splitting any non-hanging and non-degenerate birdcage in zone A in three non-hanging birdcages, and still stay in  $A'_w$ .

If the non-hanging birdcage is the leftmost one, it can easily be split in three parts via multiplication by  $U_0$ , as illustrated below

$$\begin{array}{c} \text{Diagram with red and blue arcs and vertical lines} \\ \text{Labels: } 1, 2, \dots, 2k+1, \dots, n \end{array} = \begin{array}{c} \text{Diagram with red and blue arcs and vertical lines} \\ \text{Labels: } 1, 2, \dots, 2k+1, \dots, n \end{array} \quad (2.31)$$

Note that this belongs to  $A'_w$ . In the non-hanging birdcage is not the leftmost one, we first notice that multiplication with appropriate  $U_i$ 's has the effect of 'moving' a dot from one birdcage to its neighbouring birdcage, as illustrated below in the following two examples.

(2.32)

Using this we can also 'move' any non-hanging birdcage to the leftmost position and then multiply it by  $U_0$  to split it in three birdcages. Next, we use (2.32) to move the birdcages to the desired positions. The result of this belongs to  $A'_w$  and so the symmetry in zone A has been broken.

In fact, once we have the right number of birdcages in zone A, we can use successive multiplications of the types given in (2.32), to obtain any combination of desired birdcage lengths, as opposed to (2.31) that always produces degenerate birdcages.

Now in (2.30), we must also break the symmetry with respect to birdcage lengths in zone B. But in order to break this symmetry we proceed just as we did in the last step for zone A, applying (2.32) successively, adjusting the lengths of the relevant birdcages until they are as desired.

All in all we have now shown that any diagram of the form described in (2.33) belongs to  $A'_w$ , where the number and the lengths of the top and bottom birdcages in zone A may differ, as may the lengths of birdcages in zone B.

(2.33)

Finally, to conclude the proof of  $A'_w \cong A_w$ , we observe that the process, illustrated in (1.78), of replacing a degenerate non-hanging full birdcage by a non-hanging non-degenerate full birdcage can be realized as the multiplication on top or bottom with a diagram of the form (2.29). Below we give an example.

(2.34)

In order to prove the other inclusion  $A'_w \subseteq A_w$  we need to change the argument of the corresponding statement in [33] since it, as already mentioned, depends on dimension arguments in linear algebra (over  $\mathbb{C}$ ).

We first observe that  $U_i \in A_w$  for  $i = 0, 1, \dots, n-2$ . Hence, to show  $A'_w \subseteq A_w$  it is enough to verify that  $A_w$  is invariant under left and right multiplication by the  $U_i$ 's.

Let therefore  $D$  be a diagram for  $A_w$ . We first choose  $i > 0$  and proceed to give a description of the effect of multiplying  $U_i$  below on  $D$ , that is we describe  $U_i D$  in terms of  $D$ . Let  $l_1, l_2$  and  $l_3$  be the arcs in  $D$  that has bottom boundary points  $i, i+1$  and  $i+2$  of  $D$ , respectively. Without loss of generality we may assume that  $l_1$  and  $l_3$  are red, and that  $l_2$  is blue. Recall that an arc  $l$  of  $D$  is a boundary dot arc if one of its vertices is a dot and the other one is a boundary point.

**Case 1:** This is the case where  $l_1$  and  $l_2$  have a common vertex in  $D$ , or, more generally, that  $l_1$  and  $l_2$  are connected in  $D$ . We then have that  $l_2$  is a boundary dot arc. It now follows from the isotopy relations (1.72) and the relation  $U_i^2 = -2U_i$ , see Theorem 2.2.1, that  $U_i D = -2D$ , since relation (1.64) implies that the scalar  $-2$  moves to the left of  $D$ . Hence we get that  $U_i D \in A_w$ . Here is an illustration, where we for simplicity leave out the top part of the diagrams.

$$\text{Diagram 1} = \text{Diagram 2} = -2 \text{Diagram 3} . \quad (2.35)$$

**Case 2:** This is the case where  $l_2$  is a boundary dot arc, whereas  $l_1$  and  $l_3$  are the rightmost and leftmost arcs of birdcageages, respectively. Note that in this situation the bottom boundary points  $i$  and  $i+1$  belong to zone A of  $D$ . We here get that  $U_i D = \alpha_t D_1$  where  $D_1$  is the diagram obtained from  $D$  by concatenating horizontally the two birdcageages, with an extra dot in the middle. Since  $D_1 \in A_w$ , this case is also OK. Here is an illustration, once again without the top parts of the diagrams.

$$\text{Diagram 1} = \alpha_t \text{Diagram 2} = \alpha_t \text{Diagram 3} = \alpha_t \text{Diagram 4} . \quad (2.36)$$

**Case 3:** This is the case where  $l_2$  has a trivalent vertex, whereas  $l_1$  and  $l_3$  are the rightmost and leftmost arcs of birdcageages, respectively. In this case we get  $U_i D = D_1$  where  $D_1$  is obtained from  $D$  by eliminating  $l_2$  and joining the birdcageages involving  $l_1$  and  $l_3$ , with an extra dot in the middle. Once again, we get that  $D_1 \in A_w$ , and so this case is also OK. Here is an illustration.

$$\text{Diagram 1} = \text{Diagram 2} = \text{Diagram 3} . \quad (2.37)$$

**Case 4:** This is the case where  $l_1$  is the leftmost arc of a birdcageage, whereas  $l_2$  has a trivalent vertex  $V$ . Let  $B_1$  be the birdcageage that lies to the southwest of  $V$  and let  $B_2$  be the birdcageage that lies to the southeast of  $V$ . Then  $U_i D = D_1$  where  $D_1$  is obtained from  $D$  by joining  $B_1$  and  $l_1$  and adding a boundary dot arc to the left of  $B_1$ . We have that  $D_1 \in A_w$  and so this case is done. Here is an example, without the top parts of the diagrams.

$$\text{Diagram 1} = \text{Diagram 2} = \text{Diagram 3} . \quad (2.38)$$

**Case 5:** This is the identical to case 4 except that both vertices of  $l_2$  are supposed to be boundary points. Let  $B$  be the birdcageage that lies below  $l_2$ . Then  $U_i D = D_1$  where  $D_1$  is obtained from  $D$  by splitting  $l_2$  in two dot

boundary arcs, and  $B$  is joined with  $l_1$ . Since  $D_1 \in A_w$  we are done in this case, as well. Here is an example.

$$(2.39)$$

**Case 6:** This is the case where a vertex of  $l_2$  is a top boundary point of  $D$ . Then  $l_1$  and  $l_2$  are the rightmost and leftmost arcs of two birdcagecages  $B_1$  and  $B_2$ . We get that  $U_i D = D_1$  where  $D_1$  is obtained from  $D$  by joining  $B_1$  and  $B_2$  and splitting  $l_2$  in two dot boundary arcs. Since  $D_1 \in A_w$  we have that this case is OK as well. Here is an example.

$$(2.40)$$

**Case 7:** This is the case where  $l_2$  is the leftmost arc of a hanging birdcagecage. This case resembles case 6. We have that  $l_1$  and  $l_2$  are the rightmost and leftmost arcs of two birdcagecages  $B_1$  and  $B_2$ . Then we get that  $U_i D = D_1$  where  $D_1$  is obtained from  $D$  by joining  $B_1$  and  $B_2$  and replacing  $l_2$  by a bottom dot boundary arc. We have  $D_1 \in A_w$  and so this case is OK as well. Here is an example.

$$(2.41)$$

There are a few remaining cases to consider, but they are all small variations of the cases already studied and so we leave them to the reader.

We next consider  $i = 0$ . Let  $B$  be the leftmost bottom birdcagecage of  $D$  and let  $l$  be its leftmost bottom arc. If  $D$  is a boundary dot arc, we have  $U_0 D = \alpha_s D \in A_w$ . Otherwise we have  $U_0 D = \alpha_s D_1$  where  $D_1$  is the birdcagecage obtained from  $D$  by replacing  $l$  by a boundary dot arc, and here we also have  $U_0 D \in A_w$ . Here is an illustration of this case.

$$(2.42)$$

Finally, we observe that the description of the right multiplication  $DU_i$  is completely analogous to the description of  $U_i D$ , and so we have concluded the proof of **b**).

We now give an alternative proof of  $A'_w \subseteq A_w$ , adapting the proof in [33] and using one of the main results in [11]. Let  $Q$  be the quotient field of  $R$  and let  $QA_w := Q \otimes_R A_w$ ,  $QA'_w := Q \otimes_R A'_w$  and  $Q\mathbb{B}_{n-1}^{x,y} = Q \otimes_R \mathbb{B}_{n-1}^{x,y}$ . Since  $A_w$  and  $\mathbb{B}_{n-1}^{x,y}$  are torsion free  $R$ -modules, in fact even free, we may view  $A_w$  and  $\mathbb{B}_{n-1}^{x,y}$  as  $R$ -submodules of  $QA_w$  and  $Q\mathbb{B}_{n-1}^{x,y}$ , via the map  $D \mapsto 1 \otimes_R D$ . Similarly, we may view  $A'_w$  as an  $R$ -submodule of  $QA'_w$ , since  $A'_w$  is torsion free, being a submodule of the free  $R$ -module  $\tilde{A}_w$ .

Now the inclusion  $A_w \subseteq A'_w$  induces an inclusion  $QA_w \subseteq QA'_w$ , since  $Q \otimes_R (\cdot)$  is an exact functor, and the surjection  $\varphi : \mathbb{B}_{n-1}^{x,y} \rightarrow A'_w$  induces a surjection  $Q\mathbb{B}_{n-1}^{x,y} \rightarrow QA'_w$ . Combining this with **a**), we deduce that  $QA_w = QA'_w$  since both are  $Q$ -vector spaces of the same dimension  $\binom{2n}{n}$ .

Let us now show  $A'_w \subseteq A_w$ . As in the first proof of  $A'_w \subseteq A_w$ , it is for this enough to check that  $U_i D \in A_w$ , whenever  $D$  is a light leaves diagram in  $A_w$ . Now using  $QA_w = QA'_w$ , we find elements  $q_k \in Q$  such that

$$U_i D = \sum_{D_k \in A_w} q_k D_k \quad (2.43)$$

where  $D_k$  runs over the light leaves basis for  $A_w$ . On the other hand, as was shown in Theorem 6.11 of [11], the light leaves diagrams  $\{D_l\}$  for  $\tilde{A}_w$  form an  $R$ -basis for  $\tilde{A}_w$ , and so there also exist  $r_l \in R$  such that

$$U_i D = \sum_{D_l \in \tilde{A}_w} a_l D_l. \quad (2.44)$$

Comparing (2.43) and (2.43) we deduce that  $q_k \in R$ , and so  $U_i D \in A_w$ , as claimed.

We remark that, in a suitable sense, the alternative proof of b) is equivalent to the first proof, since the arguments in [11], that hold in the setting of a general Coxeter system  $(W, S)$ , depend on a case-by-case similar to the one carried out in our first proof.

To prove c) we argue essentially as in [33], although a little extra care has to be exercised since the algebras are defined over a commutative ring rather than a field. But by (2.14), a) and b) we have that  $\varphi$  is a surjective homomorphism between free  $R$ -modules of the same finite rank. On the other hand,  $R$  is a commutative ring with 1 and so indeed  $\varphi$  is an isomorphism, as follows from Vasconcelos' Theorem, see [48]. The proof of the Theorem is finished.  $\square$

Suppose that  $\underline{w} = s_{i_1} s_{i_2} \cdots s_{i_n}$ . Then we define  $\Lambda_w \subseteq \tilde{\Lambda}_w$  as the subset of all 'tails' of  $\tilde{\Lambda}_w$ , that is

$$\Lambda_w = \{v \in \tilde{\Lambda}_w \mid v = s_{i_k} s_{i_{k+1}} \cdots s_{i_n} \text{ for } k = 1, \dots, n\}. \quad (2.45)$$

Note that  $w \in \Lambda_w$  but  $1 \notin \Lambda_w$ . For example for  $n = 7$  we have that  $w = \mathit{stststs}$  and so

$$\Lambda_w = \{\mathit{stststs}, \mathit{tststs}, \mathit{ststs}, \mathit{tsts}, \mathit{sts}, \mathit{ts}, \mathit{s}\}. \quad (2.46)$$

Let  $\Lambda_w^c \subseteq \tilde{\Lambda}_w$  be the subset obtained from  $\Lambda_w$  by deleting the last generator of each element of  $\tilde{\Lambda}_w$ . Keeping the example  $n = 7$  we have  $\Lambda_w^c = \{\mathit{ststst}, \mathit{tstst}, \mathit{stst}, \mathit{tst}, \mathit{st}, \mathit{t}, \mathit{1}\}$ . With this definition we have

$$\tilde{\Lambda}_w = \Lambda_w \dot{\cup} \Lambda_w^c. \quad (2.47)$$

The relevance of  $\Lambda_w$  comes from the following Theorem.

**THEOREM 2.2.4.** *The triple  $(\Lambda_w, \text{Tab}_w(v), C)$  defines a cellular basis structure on  $A_w$ .*

*Proof:* By part b) of Theorem 2.2.3 we know that  $A_w$  is a subalgebra of  $\tilde{A}_w$  and so the Theorem follows immediately from Theorem 2.2.4 and the fact that for  $D_1, D_2 \in \text{Tab}_w(v)$  and  $v \in \tilde{\Lambda}_w$  we have that  $C_{D_1 D_2}^v$  belongs to  $A_w$  if and only if  $v \in \Lambda_w$ .  $\square$

By Theorem 2.2.3 we know that  $\mathbb{B}_{n-1}^{x,y} \cong A_w$  and from Theorem 2.1.3 and Theorem 2.2.4 we know that both algebras are cellular. It now seems plausible that the corresponding cell modules are isomorphic as well. This is however not automatic since the cellular structure on a cellular algebra is not unique. Our next aim is to show that the cell modules are indeed isomorphic.

For this we first need to establish a poset isomorphism  $\psi : \Lambda_w \cong \Lambda_{\pm(n-1)}$ . The sets  $\Lambda_w$  and  $\Lambda_{\pm(n-1)}$  are both of cardinality  $n$  and the respective order relations are both total, so there is in fact a unique choice of  $\psi$ . It is given by the following Lemma, where  $l(\cdot)$  is the usual Coxeter length function on  $W$ .

**LEMMA 2.2.5.** *Let  $\psi : \Lambda_w \rightarrow \Lambda_{\pm(n-1)}$  be the map defined by*

$$\psi(v) = \begin{cases} l(v) - 1 & \text{if } v \text{ begins with } s \\ -l(v) & \text{if } v \text{ begins with } t. \end{cases} \quad (2.48)$$

*Then  $\psi$  is an isomorphism of posets. We denote by  $\varphi$  the inverse  $\varphi = \psi^{-1} : \Lambda_{\pm(n-1)} \rightarrow \Lambda_w$ .*

(The different meanings of the symbol  $\varphi$ , for example as the algebra isomorphism  $\mathbb{B}_n^{x,y} \cong A_w$ , but also as the poset isomorphism  $\Lambda_{\pm(n-1)} \cong \Lambda_w$ , should not give rise to confusion). For example, if  $n = 7$  we have

$$\varphi(6, -6, 4, -4, 2, -2, 0) = (\mathit{stststs}, \mathit{tststs}, \mathit{ststs}, \mathit{tsts}, \mathit{sts}, \mathit{ts}, \mathit{s}). \quad (2.49)$$

For  $v \in \Lambda_w$  we now introduce  $C_v \in A_w$  as the double leaf diagram of the form (2.27) or (2.28) that defines  $v \in W$ , that is

$$C_\nu = \left\{ \begin{array}{c} \text{Diagram 1} \\ \text{Diagram 2} \\ \text{Diagram 3} \\ \text{Diagram 4} \end{array} \right\} \quad (2.50)$$

where the vertical lines below  $\vdash \quad \dashv$  in each diagram of (2.50) define  $\nu$ .

We have that  $C_\nu = \varphi(C_\lambda)$  where  $\varphi(\lambda) = \nu$ , that is  $C_\nu$  corresponds to the blob algebra element  $C_\lambda$  defined in (2.18). Let  $A^\nu$  and  $A^{<\nu}$  be the cell ideals in  $A_w$  given by

$$A^\nu := \{aC_\nu b \mid a, b \in A_w\} \text{ and } A^{<\nu} := \{aC_u b \mid a, b \in A_w \text{ and } u < \nu\} \quad (2.51)$$

and define the cell module

$$\Delta_w(\nu) := A_w \overline{C}_\nu \subset A^\nu / A^{<\nu} \quad (2.52)$$

where  $\overline{C}_\nu = C_\nu + A^{<\nu}$ . Let  $D_\nu$  be the half-diagram corresponding to  $C_\nu$ . Then we have the following Theorem.

**THEOREM 2.2.6.**  *$\Delta_w(\nu)$  is free over  $R$  with basis  $\{\overline{C}_{D, D_\nu} \mid D \in \text{Tab}_w(\nu)\}$  where  $\overline{C}_{D, D_\nu} := C_{D, D_\nu} + A^{<\nu}$ .*

*Proof:* This follows from the algorithm given in the proof of Theorem 2.2.3.  $\square$

We then finally obtain the main result of this section.

**THEOREM 2.2.7.** *Suppose that  $\varphi(\lambda) = \nu$ . Then the isomorphism  $\varphi : \mathbb{B}_{n-1}^{x,y} \rightarrow A_w$  induces an isomorphism  $\varphi : \Delta_{n-1}^{\mathbb{B}}(\lambda) \rightarrow \Delta_w(\nu)$  of cell modules.*

*Proof:* Since  $\varphi(C_\lambda) = C_\nu$  we have that  $\varphi$  induces ideal isomorphisms  $A^\lambda \cong A^\nu$  and  $A^{<\lambda} \cong A^{<\nu}$  and hence  $A^\lambda / A^{<\lambda} \cong A^\nu / A^{<\nu}$ . But from this we deduce that  $\Delta_w(\nu)$  and  $\Delta_{n-1}^{\mathbb{B}}(\lambda)$  are isomorphic under  $\varphi$ , as claimed.  $\square$

For a general cellular algebra  $\mathcal{A}$  over  $\mathbb{k}$  with cell modules  $\{\Delta(\lambda) \mid \lambda \in \Lambda\}$  there is a canonical bilinear form  $\langle \cdot, \cdot \rangle_\lambda$  on  $\Delta(\lambda)$  that plays an important role for the representation theory of  $\mathcal{A}$ . Let  $\Lambda_0 = \{\lambda \in \Lambda \mid \langle \cdot, \cdot \rangle_\lambda \neq 0\}$  and define for  $\lambda \in \Lambda_0$  the  $\mathcal{A}$ -module  $L(\lambda) := \Delta(\lambda) / \text{rad} \langle \cdot, \cdot \rangle_\lambda$  where  $\text{rad}$  is the radical of  $\langle \cdot, \cdot \rangle_\lambda$  in the usual sense of bilinear forms. It is an  $\mathcal{A}$ -submodule of  $\Delta(\lambda)$  because  $\langle \cdot, \cdot \rangle_\lambda$  is  $\mathcal{A}$ -invariant, that is  $\langle xy, z \rangle_\lambda = \langle x, y^* z \rangle_\lambda$  for all  $x \in \mathcal{A}$  and  $y, z \in \Delta(\lambda)$ , where  $*$  is the antihomomorphism of  $\mathcal{A}$  given in Definition 1.2.1. In the case where  $\mathbb{k}$  is a field, the  $\mathcal{A}$ -modules in the set  $\{L(\lambda) \mid \lambda \in \Lambda_0\}$  are all irreducible, and each  $\mathcal{A}$ -irreducible module occurs exactly once in the set, see Theorem 3.4 in [15].

Let  $\langle \cdot, \cdot \rangle_{n,\nu}^w$  be the bilinear form on  $\Delta_w(\nu)$  and let  $\langle \cdot, \cdot \rangle_{n-1,\lambda}^{\mathbb{B}}$  be the bilinear form on  $\Delta_{n-1}^{\mathbb{B}}(\lambda)$ . Then we have the following Theorem.

**THEOREM 2.2.8.**  *$\langle \cdot, \cdot \rangle_{n-1,\lambda}^{\mathbb{B}}$  and  $\langle \cdot, \cdot \rangle_{n,\nu}^w$  are equivalent under  $\varphi$ , in other words*

$$\langle \varphi(s), \varphi(t) \rangle_{n,\nu}^w = \langle s, t \rangle_{n-1,\lambda}^{\mathbb{B}} \text{ for } s, t \in \Delta_{n-1}^{\mathbb{B}}(\lambda) \quad (2.53)$$

where  $\varphi(\lambda) = \nu$ .

*Proof:* A bilinear and invariant form  $\langle \cdot, \cdot \rangle$  on  $\Delta_w(\nu)$  corresponds to an  $A_w$ -homomorphism  $\Delta_{n-1}^{\mathbb{B}}(\lambda) \rightarrow \Delta_{n-1}^{\mathbb{B},*}(\lambda)$  where  $\Delta_{n-1}^{\mathbb{B},*}(\lambda)$  is the dual of  $\Delta_{n-1}^{\mathbb{B}}(\lambda)$ . For  $Q$  the fraction field of  $R$  and  $\overline{Q}$  its algebraic closure we set  $\Delta_{n-1}^{\overline{Q}}(\lambda) := \Delta_{n-1}^{\mathbb{B}}(\lambda) \otimes_R \overline{Q}$ . Then  $\Delta_{n-1}^{\overline{Q}}(\lambda)$  is irreducible and so by Schur's Lemma  $\Delta_{n-1}^{\overline{Q}}(\lambda) \rightarrow \Delta_{n-1}^{\overline{Q},*}(\lambda)$  is unique up to a scalar. Hence  $\langle \cdot, \cdot \rangle$  is unique up to a scalar  $\mu$ , that is

$$\langle \psi(a), \psi(b) \rangle_{n-1,\lambda}^{\mathbb{B}} = \mu \langle a, b \rangle_{n,\nu}^w \text{ for } a, b \in \Delta_{w,\nu}(\lambda) \quad (2.54)$$

but using  $a = b = C_\nu$ , one checks that  $\mu = 1$  and so the Theorem follows.  $\square$

The purpose of the present thesis is to study the form  $\langle \cdot, \cdot \rangle_{n,\nu}^w$ . In view of Theorem 2.2.8, we can instead study the form  $\langle \cdot, \cdot \rangle_{n-1,\lambda}^{\mathbb{B}}$ , which turns out to be easier to handle.

### 3. Restriction of $\Delta_n^{\mathbb{B}}(\lambda)$ to $\mathbb{T}\mathbb{L}_n$

As already mentioned, there is an embedding  $\mathbb{T}\mathbb{L}_n \subseteq \mathbb{B}_n^{x,y}$  which at the diagrammatic level is an embedding of Temperley-Lieb diagrams in blob diagrams. This gives rise to a restriction functor  $\text{Res} = \text{Res}_{\mathbb{T}\mathbb{L}_n}^{\mathbb{B}_n^{x,y}}$  from  $\mathbb{B}_n^{x,y}$ -modules to  $\mathbb{T}\mathbb{L}_n$ -modules. In this section we study the application of  $\text{Res}$  on  $\Delta_n^{\mathbb{B}}(\lambda)$ .

Recall from Theorem 2.1.4 that the cell module  $\Delta_n^{\mathbb{B}}(\lambda)$  for  $\mathbb{B}_n^{x,y}$  (resp.  $\Delta_n^{\mathbb{T}\mathbb{L}}(\lambda)$  for  $\mathbb{T}\mathbb{L}_n$ ) has basis  $\{\overline{C}_{st_\lambda} \mid s \in \text{Tab}(\lambda)\}$ . From now on, if  $\lambda \geq 0$  we shall identify  $\overline{C}_{st_\lambda}$  with  $s$  so that we consider the basis for  $\Delta_n^{\mathbb{B}}(\lambda)$  to consist of half-diagrams. For example, the basis of the  $\mathbb{B}_5^{x,y}$ -module  $\Delta_5^{\mathbb{B}}(1)$  consists of the following half-diagrams

The diagram shows three rows of half-diagrams. The first row has five diagrams: a single arc, a vertical line, a vertical line with a cap, a vertical line with a cup, and a vertical line with a cap and a cup. The second row has four diagrams: a vertical line with a cap and a cup, a vertical line with a cap and a cup, a vertical line with a cap and a cup, and a vertical line with a cap and a cup. The third row has one diagram: a vertical line with a cap and a cup.

$$(2.55)$$

If  $\lambda < 0$  we still identify  $\overline{C}_{st_\lambda}$  with  $s$ , but with the leftmost propagating line marked. For example, the basis of the  $\mathbb{B}_5^{x,y}$ -module  $\Delta_5^{\mathbb{B}}(-3)$  consists of the following half-diagrams

The diagram shows two rows of half-diagrams. The first row has four diagrams: a vertical line with a cap and a cup, a vertical line with a cap and a cup, a vertical line with a cap and a cup, and a vertical line with a cap and a cup. The second row has one diagram: a vertical line with a cap and a cup.

$$(2.56)$$

Finally, for the  $\mathbb{T}\mathbb{L}_n$ -module  $\Delta_n^{\mathbb{T}\mathbb{L}}(\lambda)$  we once again identify  $\overline{C}_{st_\lambda}$  with  $s$ . Thus, for example the basis of the  $\mathbb{T}\mathbb{L}_5$ -module  $\Delta_5^{\mathbb{T}\mathbb{L}}(1)$  consists of the half-diagrams that appear in the first row of (2.55).

In terms of these identifications the action of  $D \in \mathbb{B}_n^{x,y}$  (resp.  $D \in \mathbb{T}\mathbb{L}_n$ ) on  $D_1 \in \Delta_n^{\mathbb{B}}(\lambda)$  (resp.  $D_1 \in \Delta_n^{\mathbb{T}\mathbb{L}}(\lambda)$ ) is given by concatenation with  $D_1$  on top of  $D$ , followed by the same reduction process of extra blobs and internal loops, marked or unmarked, that we gave for  $\mathbb{B}_n^{x,y}$  (resp.  $\mathbb{T}\mathbb{L}_n$ ) itself. If the result of this does not belong to the span of half-diagrams for  $\Delta_n^{\mathbb{B}}(\lambda)$  (resp.  $\Delta_n^{\mathbb{T}\mathbb{L}}(\lambda)$ ), we have  $DD_1 = 0$ .

Suppose that  $\lambda \in \Lambda_{\pm n}$  and set  $k := \frac{n - |\lambda|}{2}$ . We then define a filtration  $0 = \mathcal{F}^{-1}(\lambda) \subset \mathcal{F}^0(\lambda) \subset \dots \subset \mathcal{F}^k(\lambda) = \Delta_n^{\mathbb{B}}(\lambda)$  of  $\Delta_n^{\mathbb{B}}(\lambda)$  via

$$\mathcal{F}^i(\lambda) := \begin{cases} \text{span}_R\{s \in \text{Tab}(\lambda) \text{ has } i \text{ or less blobs}\} & \text{if } \lambda \geq 0 \\ \text{span}_R\{s \in \text{Tab}(\lambda) \text{ has } i + 1 \text{ or less blobs}\} & \text{if } \lambda < 0. \end{cases} \quad (2.57)$$

For example, for  $\lambda$  as in (2.55) we have that  $\mathcal{F}^0(\lambda)$  is the span of the diagrams of the first row,  $\mathcal{F}^1(\lambda)$  is the span of the diagrams of the first two rows and  $\mathcal{F}^2(\lambda) = \Delta_5^{\mathbb{B}}(1)$ .

The following result is the analogue of Lemma 8.2 from [9].

LEMMA 2.3.1.

- $\mathcal{F}^i(\lambda)$  is a  $\mathbb{T}\mathbb{L}_n$ -submodule of  $\text{Res}\Delta_n^{\mathbb{B}}(\lambda)$ .
- There is a homomorphism of  $\mathbb{T}\mathbb{L}_n$ -modules  $\pi_i : \mathcal{F}^i(\lambda) \rightarrow \Delta_n^{\mathbb{T}\mathbb{L}}(|\lambda| + 2i)$  that induces an isomorphism

$$\overline{\pi}_i : \mathcal{F}^i(\lambda) / \mathcal{F}^{i-1}(\lambda) \cong \Delta_n^{\mathbb{T}\mathbb{L}}(|\lambda| + 2i). \quad (2.58)$$

*Proof:* a) follows from the fact that the action of  $\mathbb{T}\mathbb{L}_n$  does not produce new blobs. To show b), we use the map  $\pi_i : \mathcal{F}^i(\lambda) \rightarrow \Delta_n^{\mathbb{T}\mathbb{L}}(|\lambda| + 2i)$  that transforms a marked southern arc to two propagating lines, and removes the mark on any propagating line. For example, for  $\Delta_5^{\mathbb{B}}(1)$  we have that  $\pi_1$  transforms the diagrams of the second row of (2.55) to the following diagrams

The diagram shows four diagrams: a vertical line with a cap and a cup, a vertical line with a cap and a cup, a vertical line with a cap and a cup, and a vertical line with a cap and a cup.

$$(2.59)$$



As in [9], one readily checks that  $\pi_i$  is a homomorphism of  $\mathbb{T}\mathbb{L}_n$ -modules, that induces an isomorphism  $\bar{\pi}_i : \mathcal{F}^i(\lambda)/\mathcal{F}^{i-1}(\lambda) \cong \Delta_n^{\mathbb{T}\mathbb{L}}(|\lambda| + 2i)$ .  $\square$

Our next goal is to construct sections for the  $\pi_i$ 's from Lemma 2.3.1. For this we need to use the *Jones-Wenzl idempotent*  $\mathbf{JW}_n$  for  $\mathbb{T}\mathbb{L}_n$  from Definition 1.3.1. We recall that the  $\mathbf{JW}_n$  element satisfies the conditions

$$\text{coef}_1(\mathbf{JW}_n) = 1 \text{ and } \cup_i \mathbf{JW}_n = \mathbf{JW}_n \cup_i = 0 \text{ for all } i = 1, 2, \dots, n-1 \quad (2.60)$$

where  $\text{coef}_1(\mathbf{JW}_n)$  denotes the coefficient of 1 when  $\mathbf{JW}_n$  is expanded in the diagram basis for  $\mathbb{T}\mathbb{L}_n$ .

Additionally, important properties of the  $\mathbf{JW}_n$ 's are their idempotency from Lemma 1.3.3, as already mentioned, and their invariance under vertical reflection as well as horizontal reflection, that is  $*$ . Furthermore, they satisfy the following absorption property

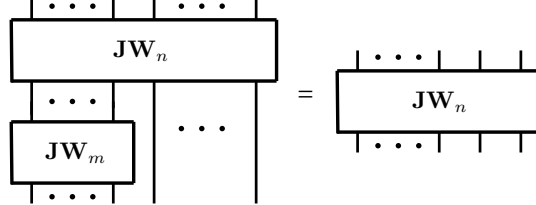

$$\text{Diagrammatic equation (2.61) showing the absorption property of the Jones-Wenzl idempotent. On the left, a box labeled } \mathbf{JW}_n \text{ is stacked on top of a box labeled } \mathbf{JW}_m \text{. The top box has } n \text{ vertical lines, and the bottom box has } m \text{ vertical lines. Ellipses indicate additional lines. This is equal to a single box labeled } \mathbf{JW}_n \text{ with } n \text{ vertical lines. Ellipses indicate additional lines.} \quad (2.61)$$

where  $m \leq n$ , by Lemma 1.3.8.

We now return to the  $\mathbb{B}_n^{x,y}$ -module  $\Delta_n^{\mathbb{B}}(\lambda)$  and its filtration  $\{\mathcal{F}^i(\lambda)\}$ . For  $i = 0, \dots, k$  we define  $e_i^\lambda \in \mathcal{F}^i(\lambda)$  as the following element

$$e_i^\lambda = \begin{cases} \text{Diagram with } i \text{ blobs and } |\lambda| \text{ vertical lines} & \text{if } \lambda \geq 0 \\ \text{Diagram with } i+1 \text{ blobs and } |\lambda| \text{ vertical lines} & \text{if } \lambda < 0 \end{cases} \quad (2.62)$$

that is, the number of blobs on  $e_i^\lambda$  is  $i$  if  $\lambda \geq 0$  and  $i+1$  if  $\lambda < 0$ . In general, for  $D$  any Temperley-Lieb diagram, we define  $1^j D$  as the left concatenation of  $j$  vertical lines on  $D$ , and we extend this definition linearly to the Temperley-Lieb algebra itself. For example, for  $j = n - |\lambda| - 2i$  we have  $1^j \mathbf{JW}_{|\lambda|+2i} \in \mathbb{T}\mathbb{L}_n$  which we depict as follows

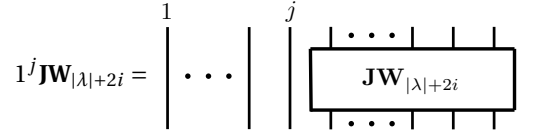

$$1^j \mathbf{JW}_{|\lambda|+2i} = \text{Diagram with } j \text{ vertical lines followed by a box labeled } \mathbf{JW}_{|\lambda|+2i} \text{ with } |\lambda|+2i \text{ vertical lines. Ellipses indicate additional lines.} \quad (2.63)$$

With this choice of  $j$  we define elements  $f_i^\lambda \in \mathcal{F}^i(\lambda)$  as follows

$$f_i^\lambda := (1^j \mathbf{JW}_{|\lambda|+2i}) e_i^\lambda = \begin{cases} \text{Diagram with } i \text{ blobs and } |\lambda| \text{ vertical lines, followed by } \mathbf{JW}_{|\lambda|+2i} & \text{if } \lambda \geq 0 \\ \text{Diagram with } i+1 \text{ blobs and } |\lambda| \text{ vertical lines, followed by } \mathbf{JW}_{|\lambda|+2i} & \text{if } \lambda < 0. \end{cases} \quad (2.64)$$

LEMMA 2.3.2. *Let  $\pi_i : \mathcal{F}^i(\lambda) \rightarrow \Delta_n^{\mathbb{T}\mathbb{L}}(|\lambda| + 2i)$  be the homomorphism from Lemma 2.3.1. We have that*

$$\pi_i(e_i^\lambda) = \pi_i(f_i^\lambda). \quad (2.65)$$

*Proof:* We show that if  $D \neq 1$  is any diagram appearing in the expansion of  $\mathbf{JW}_{|\lambda|+2i}$  then  $(1^j D) e_i^\lambda \in \mathcal{F}^{i-1}(\lambda)$ , where  $j = n - |\lambda| - 2i$ , from which the proof of the Lemma follows since  $\ker \pi_i = \mathcal{F}^{i-1}(\lambda)$  and  $\text{coef}_1(\mathbf{JW}_{|\lambda|+2i}) = 1$ . To prove this claim we first consider  $\lambda \geq 0$ . Any  $D \neq 1$  in the expansion of  $\mathbf{JW}_{|\lambda|+2i}$  contains at least one arc connecting two northern points. If that arc only involves blobbed arcs in (2.64), illustrated with red below, or

only involves vertical lines in (2.64), illustrated with blue below, then  $(1^j D)e_i^\lambda$  has strictly less blobs than  $e_i^\lambda$  or has strictly less propagating lines than  $e_i^\lambda$ , proving the claim in these cases.

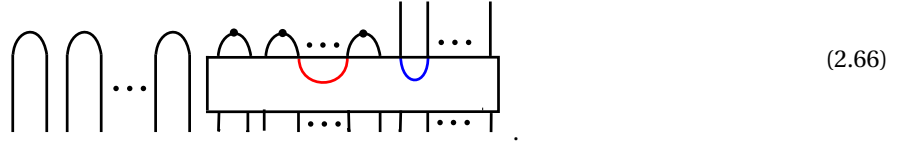

If the arc involves both the blobbed arcs in (2.64) and the vertical lines in (2.64), then either we will be in the previous case or there will be a, possibly different, arc that involves the last blobbed arc and the first vertical line in (2.64), illustrated with blue below. But then  $(1^j D)e_i^\lambda$  has a vertical blobbed line and is zero in  $\Delta_n^{\mathbb{B}}(\lambda)$ , finishing the proof of the case  $\lambda \geq 0$ .

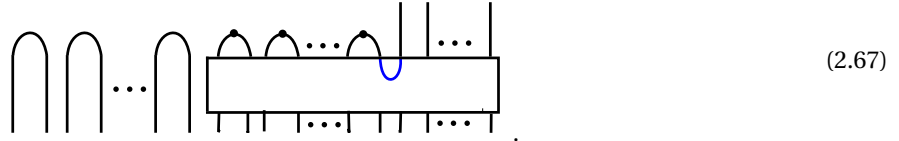

The case  $\lambda < 0$  is shown in a similar way. □

We now define the  $\mathbb{T}\mathbb{L}_n$ -module  $S_i(\lambda)$  via

$$S_i(\lambda) := \mathbb{T}\mathbb{L}_n f_i^\lambda \subseteq \mathcal{F}^i(\lambda). \quad (2.68)$$

Recall the bilinear form  $\langle \cdot, \cdot \rangle_{n,\lambda}^{\mathbb{B}}$  on  $\Delta_n^{\mathbb{B}}(\lambda)$ . In terms of half-diagrams  $D, D_1$  for  $\Delta_n^{\mathbb{B}}(\lambda)$ , we have that  $\langle D, D_1 \rangle_{n,\lambda}^{\mathbb{B}}$  is given by expanding  $D^* D_1$  in terms of the diagram basis for  $\mathbb{B}_{|\lambda|}^{x,y}$  and taking the coefficient of 1 if  $\lambda > 0$ , the coefficient of  $\emptyset$  if  $\lambda = 0$  and the coefficient of  $\cup_0$  if  $\lambda < 0$ . For example, for  $\langle \cdot, \cdot \rangle_{5,1}^{\mathbb{B}}$  we have

$$\left\langle \begin{array}{c} \text{arc} \\ \text{arc} \\ | \end{array}, \begin{array}{c} \text{arc} \\ \text{arc} \\ | \end{array} \right\rangle_{5,1} = \text{coef}_1 \left( \begin{array}{c} \bigcirc \\ \bigcirc \\ | \end{array} \right) = -2xy. \quad (2.69)$$

On the other hand, a similar description of the bilinear form  $\langle \cdot, \cdot \rangle_{n,\lambda}^{\mathbb{T}\mathbb{L}}$  on  $\Delta_n^{\mathbb{T}\mathbb{L}}(\lambda)$  was given in Lemma 1.2.9. With this notation we can now prove the following Theorem.

**THEOREM 2.3.3.**

- a) We have  $(e_j^\lambda)^* \mathbb{T}\mathbb{L}_n f_i^\lambda = 0$  for  $j < i$ .
- b) We have  $\langle \mathcal{F}^{i-1}(\lambda), S_i(\lambda) \rangle_{n,\lambda}^{\mathbb{B}} = 0$ .
- c) We have  $S_i(\lambda) \cap \mathcal{F}^{i-1}(\lambda) = 0$ .
- d) The  $\mathbb{T}\mathbb{L}_n$ -modules  $S_i(\lambda)$  and  $\Delta_n^{\mathbb{T}\mathbb{L}}(|\lambda| + 2i)$  are isomorphic.

*Proof:* To show a) we must check that the following diagram is zero for every diagram  $D$  for  $\mathbb{T}\mathbb{L}_n$ .

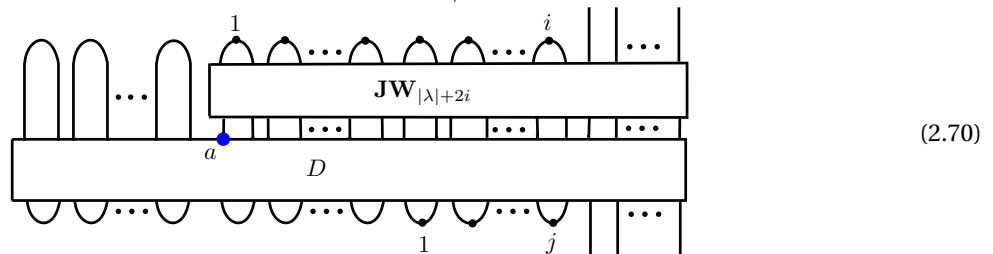

Let  $a := n - |\lambda| - 2i + 1$  and consider all possible cases for the line  $L$  leaving the  $a$ 'th northern point of  $D$ , indicated with blue in (2.70).

If  $L$  pairs  $a$  with a northern point of  $D$  which is located to the right of  $a$ , then  $L$  is a northern arc and so we get immediately by (2.60) that (2.70) is zero. If  $L$  pairs  $a$  with a southern point of  $D$  which is located strictly to the right of  $a$ , then the area to the right of  $L$  has strictly more northern than southern points and so there will be

a northern arc to the right of  $a$ . We then conclude once again by (2.60) that (2.70) is zero. This is the situation indicated in the figure below.

$$= 0. \quad (2.71)$$

If  $L$  pairs  $a$  with a southern point which is located either directly below or to the left of  $a$ , then it will be a left endpoint of one of the southern arcs of  $D$ , since the parities of the numbers of northern and southern points of  $D$  to the left of  $L$  must be the same. If the right endpoint of that arc is connected to a northern point of  $D$ , then once again by (2.60) we get that (2.70) is zero, so let us assume that it is connected to a southern point of  $D$  via a line  $A_1$ . That southern point must be a left endpoint of an arc below  $D$  since otherwise the number of southern points below  $A_1$  would be odd. If the arc is unmarked and its right endpoint is joined to a northern point of  $D$ , we get once again by (2.60) that (2.70) is zero, so let us suppose that it is joined to another southern point of  $D$  via a line  $A_2$ . Repeating the previous argument, the right endpoint of  $A_2$  must be the left endpoint of an arc whose right endpoint, in case the arc is unmarked, is connected by a line  $A_3$  to another southern point of  $D$ . Repeating this argument, we produce a series of southern lines  $A_1, A_2, \dots, A_k$ , that finally ends up in either an endpoint of one of the blobbed southern arcs below  $D$ , or in an endpoint of one of the vertical lines below  $D$ . But since  $j < i$  we then conclude that not all northern points of  $D$  to the right of  $a$  can be endpoints of propagating lines, and so we conclude by (2.60) that (2.70) is zero. Below we indicate the argument.

$$= 0. \quad (2.72)$$

Finally, if  $L$  pairs  $a$  with a northern point of  $D$  to the left of  $a$ , the argument is essentially the same as in the previous case. We indicate it as follows

$$= 0. \quad (2.73)$$

To show b), we first observe that, as a  $\mathbb{T}\mathbb{L}_n$ -module,  $\mathcal{F}^{i-1}(\lambda)$  is generated by  $\{e_j^\lambda \mid j < i\}$ , as follows from Lemma 2.3.1. In view of this, **b** follows from **a**) and the definition of  $\langle \cdot, \cdot \rangle_{n, \lambda}^{\mathbb{B}}$ .

We next show c). Suppose that there is  $s \in S_i(\lambda) \cap \mathcal{F}^{i-1}(\lambda) \setminus \{0\}$ . To get the desired contradiction, we first claim that the restriction of  $\langle \cdot, \cdot \rangle_{n, \lambda}^{\mathbb{B}}$  to  $\mathcal{F}^{i-1}(\lambda)$  is non-degenerate. Indeed, any diagram in  $\mathcal{F}^{i-1}(\lambda)$  can be viewed as a diagram for  $\Delta_n^{\mathbb{T}\mathbb{L}}(|\lambda|)$ , decorated with certain blobs, see for example (2.55) and (2.56). For  $D$  a diagram for  $\mathcal{F}^{i-1}(\lambda)$  we denote by  $\mathbb{T}\mathbb{L}(D)$  the associated diagram for  $\Delta_n^{\mathbb{T}\mathbb{L}}(|\lambda|)$ , obtained by removing the blobs. Then via the

specialization  $x = 1, y = -2$  given in (2.9), we have that

$$\left( \langle D, D_1 \rangle_{n, \lambda}^{\mathbb{B}} \right)_{|x=1, y=-2} = \langle \mathbb{T}\mathbb{L}(D), \mathbb{T}\mathbb{L}(D_1) \rangle_{n, |\lambda|}^{\mathbb{T}\mathbb{L}} \quad (2.74)$$

as one checks from the definitions. Since  $\langle \cdot, \cdot \rangle_{n, |\lambda|}^{\mathbb{T}\mathbb{L}}$  is non-degenerate, we now deduce from (2.74) that also the restriction of  $\langle \cdot, \cdot \rangle_{n, \lambda}^{\mathbb{B}}$  to  $\mathcal{F}^{i-1}(\lambda)$  is non-degenerate, as claimed. Hence, for  $s \in S_i(\lambda) \cap \mathcal{F}^{i-1}(\lambda) \setminus \{0\}$  there exists an  $s_1 \in \mathcal{F}^{i-1}(\lambda)$  such that  $\langle s, s_1 \rangle_{n, \lambda}^{\mathbb{B}} \neq 0$ , which is in contradiction with **b**). This proves **c**).

To show **d**) we consider the composition

$$f_i : S_i(\lambda) \subseteq \mathcal{F}^i(\lambda) \longrightarrow \mathcal{F}^i(\lambda) / \mathcal{F}^{i-1}(\lambda) \cong \Delta_n^{\mathbb{T}\mathbb{L}}(|\lambda| + 2i) \quad (2.75)$$

where the last isomorphism is given in Lemma 2.3.1. In view of Lemma 2.3.2, we get that  $f_i$  is surjective. On the other hand, the kernel of  $f_i$  is  $S_i(\lambda) \cap \mathcal{F}^{i-1}(\lambda)$  which is zero by **c**), and so  $f_i$  is also injective. The Theorem is proved.  $\square$

**COROLLARY 2.3.4.** *Set as before  $k := \frac{n - |\lambda|}{2}$ . Then, with respect to  $\langle \cdot, \cdot \rangle_{n, \lambda}^{\mathbb{B}}$ , there is an orthogonal direct sum decomposition of  $\text{Res} \Delta_n^{\mathbb{B}}(\lambda)$ , as follows*

$$\text{Res} \Delta_n^{\mathbb{B}}(\lambda) = S_1(\lambda) \oplus \dots \oplus S_k(\lambda). \quad (2.76)$$

*Proof:* Combining Lemma 2.3.2 with **c**) of Theorem 2.3.3, we get that

$$\text{Res} \mathcal{F}^i(\lambda) = S_i(\lambda) \oplus \mathcal{F}^{i-1}(\lambda) \quad (2.77)$$

and the Corollary follows by induction on this formula.  $\square$

The Corollary allows us to diagonalize  $\langle \cdot, \cdot \rangle_{n, \lambda}^{\mathbb{B}}$  as follows. The restriction of  $\langle \cdot, \cdot \rangle_{n, \lambda}^{\mathbb{B}}$  to  $S_i(\lambda)$  defines a  $\mathbb{T}\mathbb{L}_n$ -invariant bilinear form on  $S_i(\lambda)$  which by Schur's Lemma, arguing as in the proof of Theorem 2.2.8, must be equivalent to  $\langle \cdot, \cdot \rangle_{n, |\lambda|+2i}^{\mathbb{T}\mathbb{L}}$ , that is for  $s, t \in S_i(\lambda)$  we have that

$$\langle s, t \rangle_{n, \lambda}^{\mathbb{B}} = c_i(x, y) \langle f_i(s), f_i(t) \rangle_{n, |\lambda|+2i}^{\mathbb{T}\mathbb{L}} \quad (2.78)$$

for some  $c_i(x, y) \in R$ . On the other hand, by our choice of ground field  $\mathbb{C}$ , we have that  $\langle \cdot, \cdot \rangle_{n, |\lambda|+2i}^{\mathbb{T}\mathbb{L}}$  is equivalent to the standard bilinear form on  $\Delta_n^{\mathbb{T}\mathbb{L}}(|\lambda| + 2i)$  given by the identity matrix. In other words, there is an  $R$ -basis  $f_1^i, f_2^i, \dots, f_m^i$  for  $\Delta_n^{\mathbb{T}\mathbb{L}}(|\lambda| + 2i)$  such that

$$\langle f_k^i, f_l^i \rangle_{n, |\lambda|+2i}^{\mathbb{T}\mathbb{L}} = \delta_{kl} \quad (2.79)$$

where  $\delta_{kl}$  is the Kronecker delta. Combining (2.78) and (2.79) we then conclude that also  $\langle \cdot, \cdot \rangle_{n, \lambda}^{\mathbb{B}}$  can be diagonalized. To be precise, there is an  $R$ -basis  $\mathcal{B} = \{b_1, \dots, b_m\}$  for  $\Delta_n^{\mathbb{B}}(\lambda)$  such that the matrix  $M_{n, \lambda}^{\mathbb{B}}(x, y) = M_{n, \lambda}^{\mathbb{B}} := \left( \langle b_i, b_j \rangle_{n, \lambda}^{\mathbb{B}} \right)_{i, j=1, \dots, m}$  for  $\langle \cdot, \cdot \rangle_{n, \lambda}^{\mathbb{B}}$  has the following form

$$M_{n, \lambda}^{\mathbb{B}} = \begin{pmatrix} c_0(x, y) I_{d_0} & 0 & \dots & 0 \\ 0 & c_1(x, y) I_{d_1} & \dots & 0 \\ \vdots & \vdots & \ddots & \vdots \\ 0 & 0 & \dots & c_k(x, y) I_{d_k} \end{pmatrix} \quad (2.80)$$

where  $d_i = \dim \Delta_n^{\mathbb{T}\mathbb{L}}(|\lambda| + 2i)$  and  $I_{d_i}$  is the  $d_i \times d_i$ -identity matrix, whereas the 0's are 0-matrices of appropriate dimensions.

#### 4. Determination of $c_i(x, y)$

The purpose of this section is to calculate the  $c_i(x, y)$ 's from (2.78) and (2.80). This is the key calculation of the thesis. Quite surprisingly, the result turns out to be given in terms of nice expressions involving the *positive roots* for  $W$ .

For  $i = 1, 2, \dots$ , we define  $\alpha_{x, i}, \alpha_{y, i} \in \mathfrak{h}^*$  via

$$\alpha_{x, i} := ix + (i-1)y = i\alpha_s + (i-1)\alpha_t, \quad \alpha_{y, i} := iy + (i-1)x = i\alpha_t + (i-1)\alpha_s. \quad (2.81)$$

By our choice of realization for  $W$ , the following formulas for  $\alpha_{x,i}$  and  $\alpha_{y,i}$  hold, as one proves by induction using (1.57).

$$\alpha_{x,2i-1} = (st)^{i-1} \alpha_s, \quad \alpha_{y,2i} = t(st)^{i-1} \alpha_s, \quad \alpha_{y,2i-1} = (ts)^{i-1} \alpha_t, \quad \alpha_{x,2i} = s(ts)^{i-1} \alpha_t. \quad (2.82)$$

For a general Coxeter system  $(W, S)$  with realization  $\mathfrak{h}$  we define a root  $\beta \in \mathfrak{h}^*$  to be any element of the form  $\beta = w\alpha$  where  $w \in W$  and  $\alpha \in \mathfrak{h}^*$  is a simple root. The formulas in (2.82) show that  $\{\pm\alpha_{x,i}, \pm\alpha_{y,i} \mid i = 1, 2, \dots\}$  is the set of all roots for  $W$ , with  $\alpha_{x,1} = x = \alpha_s$  and  $\alpha_{y,1} = y = \alpha_t$  being the simple roots.

With this notation we can now formulate the following Theorem.

THEOREM 2.4.1.

a) Suppose that  $\lambda \geq 0$  and that  $f_i^\lambda$  is as in (2.64) but with  $j = 0$ , that is  $f_i^\lambda = f_k^\lambda$  where

$$f_k^\lambda = \begin{array}{c} \begin{array}{ccccccc} & 1 & 2 & \dots & k & 1 & 2 & \dots & \lambda \\ & \frown & \frown & \dots & \frown & | & | & \dots & | \\ \text{---} & \text{---} & \text{---} & \dots & \text{---} & \text{---} & \text{---} & \dots & \text{---} \\ & \smile & \smile & \dots & \smile & | & | & \dots & | \\ & 1 & 2 & \dots & n & & & \dots & n \end{array} \\ \text{---} \\ \text{---} \end{array} \quad (2.83)$$

Then we have that

$$\langle f_k^\lambda, f_k^\lambda \rangle_{n,\lambda}^{\mathbb{B}} = \frac{1}{\binom{n}{k}} (\alpha_{x,\lambda+2} \alpha_{x,\lambda+3} \cdots \alpha_{x,\lambda+k+1}) \alpha_{y,1} \alpha_{y,2} \cdots \alpha_{y,k} \quad (2.84)$$

where  $n = 2k + \lambda$ . (Note that the right hand side of (2.84) contains  $k$  factors  $\alpha_{x,l}$  for consecutive  $l$ 's, and also  $k$  factors  $\alpha_{y,l}$ , for consecutive  $l$ 's. For  $k = 0$ , it is set equal to 1. Note also that  $\binom{n}{k} = \dim \Delta_n^{\mathbb{B}}(\lambda)$ ).

b) Let  $c_i(x, y)$  be as in (2.78) and (2.80). Then up to multiplication by a nonzero scalar in  $\mathbb{C}$ , we have that

$$c_i(x, y) = (\alpha_{x,\lambda+2} \alpha_{x,\lambda+3} \cdots \alpha_{x,\lambda+i+1}) \alpha_{y,1} \alpha_{y,2} \cdots \alpha_{y,i} \quad (2.85)$$

(where, as before, the product is set equal to 1 if  $i = 0$ ).

*Proof:* We first prove a). For simplicity, we set  $\beta_{k,\lambda} := \langle f_k^\lambda, f_k^\lambda \rangle_{n,\lambda}^{\mathbb{B}}$  and must therefore show that  $\beta_{k,\lambda}$  satisfies the formula given in (2.84). By definition  $\beta_{k,\lambda}$  is the coefficient of 1, or the coefficient of  $\emptyset$ , if  $\lambda > 0$  or if  $\lambda = 0$ , of the following diagram

$$\begin{array}{c} \begin{array}{ccccccc} & 1 & 2 & \dots & k & 1 & 2 & \dots & \lambda \\ & \frown & \frown & \dots & \frown & | & | & \dots & | \\ \text{---} & \text{---} & \text{---} & \dots & \text{---} & \text{---} & \text{---} & \dots & \text{---} \\ & \smile & \smile & \dots & \smile & | & | & \dots & | \\ & 1 & 2 & \dots & n & & & \dots & n \end{array} \\ \text{---} \\ \text{---} \end{array} \quad (2.86)$$

For example, in view of (1.52) we have that

$$\beta_{1,0} = \begin{array}{c} \begin{array}{c} \frown \\ \text{---} \\ \smile \end{array} \\ \text{---} \\ \text{---} \end{array} = \begin{array}{c} \text{---} \\ \text{---} \\ \text{---} \end{array} + \frac{1}{2} \begin{array}{c} \text{---} \\ \text{---} \\ \text{---} \end{array} = xy + \frac{1}{2}y^2 = \frac{1}{2}\alpha_{x,2}\alpha_{y,1}. \quad (2.87)$$

We claim that  $\beta_{k,\lambda}$  satisfies the following 'deformation' of the Pascal triangle recursive formula

$$\beta_{1,0} = \frac{1}{2}\alpha_{x,2}\alpha_{y,1}, \quad \beta_{0,1} = 1, \quad \beta_{k,\lambda} = \beta_{k,\lambda-1} + \frac{k^2(\alpha_{y,k})^2}{n(n-1)}\beta_{k-1,\lambda}. \quad (2.88)$$

From this the proof of the formula (2.84) in **a**) follows by induction on  $N := k + \lambda$  as follows. The basis of the induction  $N = 1$  is immediate from (2.87) and the definitions, so let us assume that (2.84) holds for  $N - 1$  and

check it for  $N$ , using (2.88). We get

$$\begin{aligned}
\beta_{k,\lambda} &= \frac{1}{\binom{n-1}{k}} (\alpha_{x,\lambda+1} \alpha_{x,\lambda+2} \cdots \alpha_{x,\lambda+k}) \alpha_{y,1} \alpha_{y,2} \cdots \alpha_{y,k} \\
&\quad + \frac{k^2 (\alpha_{y,k})^2}{n(n-1) \binom{n-2}{k-1}} (\alpha_{x,\lambda+2} \alpha_{x,\lambda+3} \cdots \alpha_{x,\lambda+k}) \alpha_{y,1} \alpha_{y,2} \cdots \alpha_{y,k-1} \\
&= \left( \frac{\alpha_{x,\lambda+1}}{\binom{n-1}{k}} + \frac{k^2 \alpha_{y,k}}{n(n-1) \binom{n-2}{k-1}} \right) (\alpha_{x,\lambda+2} \cdots \alpha_{x,\lambda+k}) \alpha_{y,1} \alpha_{y,2} \cdots \alpha_{y,k} \\
&= \frac{1}{(n-k) \binom{n}{k}} (n \alpha_{x,\lambda+1} + k \alpha_{y,k}) (\alpha_{x,\lambda+2} \cdots \alpha_{x,\lambda+k}) \alpha_{y,1} \alpha_{y,2} \cdots \alpha_{y,k}.
\end{aligned} \tag{2.89}$$

On the other hand, using  $n = 2k + \lambda$  we get that

$$\begin{aligned}
n \alpha_{x,\lambda+1} + k \alpha_{y,k} &= (2k + \lambda) \alpha_{x,\lambda+1} + k \alpha_{y,k} \\
&= (2k + \lambda) (\lambda + 1)x + \lambda y + k(ky + (k-1)x) \\
&= (\lambda + k) ((\lambda + k + 1)x + (\lambda + k)y) = (\lambda + k) \alpha_{x,\lambda+k+1} \\
&= (n - k) \alpha_{x,\lambda+k+1}.
\end{aligned} \tag{2.90}$$

Inserting this in the last expression of (2.89) we get that

$$\beta_{k,\lambda} = \frac{1}{\binom{n}{k}} (\alpha_{x,\lambda+2} \alpha_{x,\lambda+3} \cdots \alpha_{x,\lambda+k+1}) \alpha_{y,1} \alpha_{y,2} \cdots \alpha_{y,k} \tag{2.91}$$

proving the inductive step.

In order to prove the claim (2.88) we first introduce the following diagrammatic notation for  $\beta_{k,\lambda}$

$$\beta_{k,\lambda} = \begin{array}{c} \begin{array}{ccccccc} 1 & & & k & 1 & & \lambda \\ \text{---} & \text{---} & \cdots & \text{---} & | & \cdots & | \\ \text{---} & \text{---} & \cdots & \text{---} & | & \cdots & | \\ \text{---} & \text{---} & \cdots & \text{---} & | & \cdots & | \\ \text{---} & \text{---} & \cdots & \text{---} & | & \cdots & | \\ \text{---} & \text{---} & \cdots & \text{---} & | & \cdots & | \\ \text{---} & \text{---} & \cdots & \text{---} & | & \cdots & | \\ \text{---} & \text{---} & \cdots & \text{---} & | & \cdots & | \\ \text{---} & \text{---} & \cdots & \text{---} & | & \cdots & | \\ \text{---} & \text{---} & \cdots & \text{---} & | & \cdots & | \\ \text{---} & \text{---} & \cdots & \text{---} & | & \cdots & | \end{array} \\ \text{---} & \text{---} & \cdots & \text{---} & | & \cdots & | \\ \text{---} & \text{---} & \cdots & \text{---} & | & \cdots & | \\ \text{---} & \text{---} & \cdots & \text{---} & | & \cdots & | \\ \text{---} & \text{---} & \cdots & \text{---} & | & \cdots & | \\ \text{---} & \text{---} & \cdots & \text{---} & | & \cdots & | \\ \text{---} & \text{---} & \cdots & \text{---} & | & \cdots & | \\ \text{---} & \text{---} & \cdots & \text{---} & | & \cdots & | \\ \text{---} & \text{---} & \cdots & \text{---} & | & \cdots & | \\ \text{---} & \text{---} & \cdots & \text{---} & | & \cdots & | \\ \text{---} & \text{---} & \cdots & \text{---} & | & \cdots & | \\ \text{---} & \text{---} & \cdots & \text{---} & | & \cdots & | \end{array} \tag{2.92}$$

where the numbers above the diagram indicate the cardinalities of the arcs and the vertical lines. We next recall the following recursive formula for calculating  $\mathbf{JW}_n$ , from Lemma 1.3.9:

$$\begin{array}{c} \text{---} & \text{---} & \cdots & \text{---} & | & \cdots & | \\ \text{---} & \text{---} & \cdots & \text{---} & | & \cdots & | \\ \text{---} & \text{---} & \cdots & \text{---} & | & \cdots & | \\ \text{---} & \text{---} & \cdots & \text{---} & | & \cdots & | \\ \text{---} & \text{---} & \cdots & \text{---} & | & \cdots & | \\ \text{---} & \text{---} & \cdots & \text{---} & | & \cdots & | \\ \text{---} & \text{---} & \cdots & \text{---} & | & \cdots & | \\ \text{---} & \text{---} & \cdots & \text{---} & | & \cdots & | \\ \text{---} & \text{---} & \cdots & \text{---} & | & \cdots & | \\ \text{---} & \text{---} & \cdots & \text{---} & | & \cdots & | \\ \text{---} & \text{---} & \cdots & \text{---} & | & \cdots & | \end{array} = \begin{array}{c} \text{---} & \text{---} & \cdots & \text{---} & | & \cdots & | \\ \text{---} & \text{---} & \cdots & \text{---} & | & \cdots & | \\ \text{---} & \text{---} & \cdots & \text{---} & | & \cdots & | \\ \text{---} & \text{---} & \cdots & \text{---} & | & \cdots & | \\ \text{---} & \text{---} & \cdots & \text{---} & | & \cdots & | \\ \text{---} & \text{---} & \cdots & \text{---} & | & \cdots & | \\ \text{---} & \text{---} & \cdots & \text{---} & | & \cdots & | \\ \text{---} & \text{---} & \cdots & \text{---} & | & \cdots & | \\ \text{---} & \text{---} & \cdots & \text{---} & | & \cdots & | \\ \text{---} & \text{---} & \cdots & \text{---} & | & \cdots & | \\ \text{---} & \text{---} & \cdots & \text{---} & | & \cdots & | \end{array} + \sum_{j=1}^{n-1} \frac{j}{n} \begin{array}{c} \text{---} & \text{---} & \cdots & \text{---} & | & \cdots & | \\ \text{---} & \text{---} & \cdots & \text{---} & | & \cdots & | \\ \text{---} & \text{---} & \cdots & \text{---} & | & \cdots & | \\ \text{---} & \text{---} & \cdots & \text{---} & | & \cdots & | \\ \text{---} & \text{---} & \cdots & \text{---} & | & \cdots & | \\ \text{---} & \text{---} & \cdots & \text{---} & | & \cdots & | \\ \text{---} & \text{---} & \cdots & \text{---} & | & \cdots & | \\ \text{---} & \text{---} & \cdots & \text{---} & | & \cdots & | \\ \text{---} & \text{---} & \cdots & \text{---} & | & \cdots & | \\ \text{---} & \text{---} & \cdots & \text{---} & | & \cdots & | \\ \text{---} & \text{---} & \cdots & \text{---} & | & \cdots & | \end{array} \tag{2.93}$$

where the number  $j$  indicates the position of the arc. Let us use it to show the recursive formula (2.88) for  $\beta_{k,\lambda}$ .

Concatenating on top and on bottom with the blobbed arcs, the first term of (2.93) becomes

$$\begin{array}{c} \text{---} & \text{---} & \cdots & \text{---} & | & \cdots & | \\ \text{---} & \text{---} & \cdots & \text{---} & | & \cdots & | \\ \text{---} & \text{---} & \cdots & \text{---} & | & \cdots & | \\ \text{---} & \text{---} & \cdots & \text{---} & | & \cdots & | \\ \text{---} & \text{---} & \cdots & \text{---} & | & \cdots & | \\ \text{---} & \text{---} & \cdots & \text{---} & | & \cdots & | \\ \text{---} & \text{---} & \cdots & \text{---} & | & \cdots & | \\ \text{---} & \text{---} & \cdots & \text{---} & | & \cdots & | \\ \text{---} & \text{---} & \cdots & \text{---} & | & \cdots & | \\ \text{---} & \text{---} & \cdots & \text{---} & | & \cdots & | \\ \text{---} & \text{---} & \cdots & \text{---} & | & \cdots & | \end{array} = \beta_{k,\lambda-1}. \tag{2.94}$$

We next consider the contribution to  $\beta_{k,\lambda}$  from the terms of the sum in (2.93). We first observe that concatenating on top and on bottom with the blobbed arcs, only the terms in the sum in (2.93) where  $j \leq 2k$  can

contribute to  $\beta_{k,\lambda}$  since otherwise the concatenation has the form

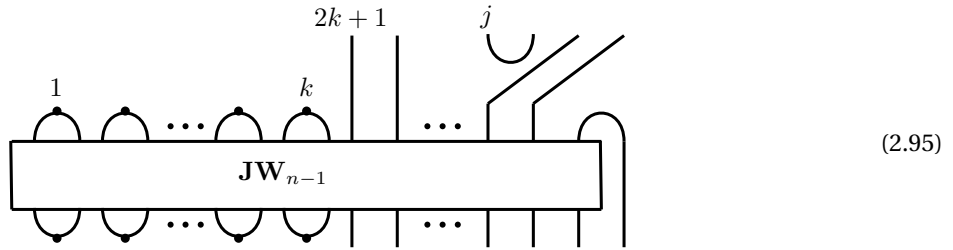

in which the  $j$ 'th northern point is connected to another northern point.

We next consider the contributions for  $j = 1, 3, \dots, 2k - 1$ . Apart from the coefficients, they are of the form indicated below (in the cases  $j = 1$  and  $j = 3$ ).

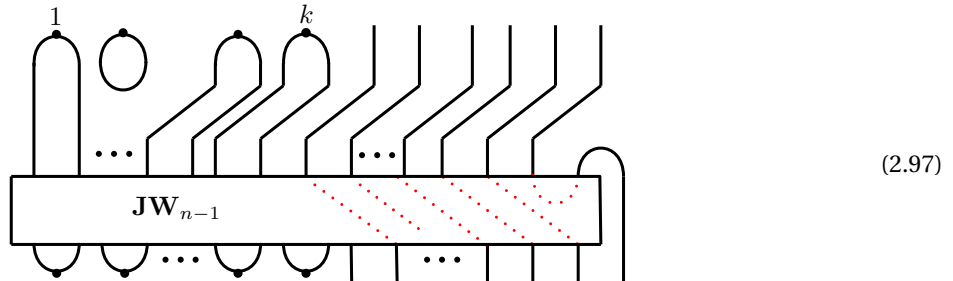
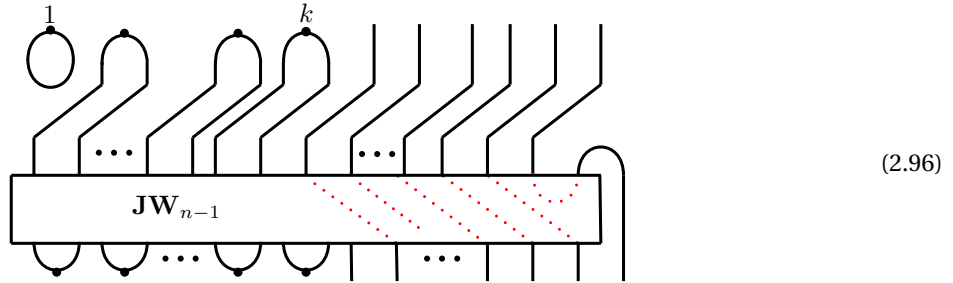

and are in fact all equal to  $y\beta'_{k,\lambda}$  where  $\beta'_{k,\lambda}$  is the diagram

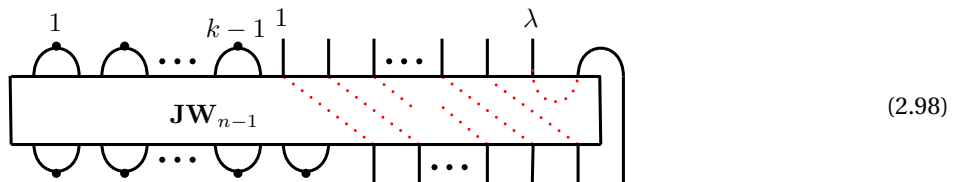

In these diagrams, the dashed lines once again refer to the summands of the Jones-Wenzl elements where the points are connected as indicated.

We then consider the contributions for  $j = 2, 4, \dots, 2k - 2$ . They are all of the form indicated below (for  $j = 2$  and  $j = 4$ )

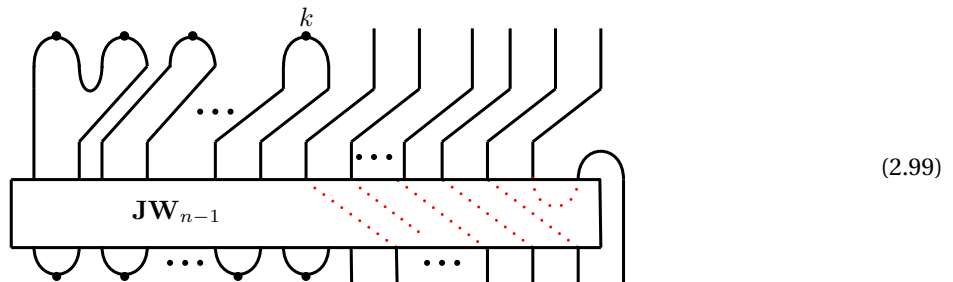

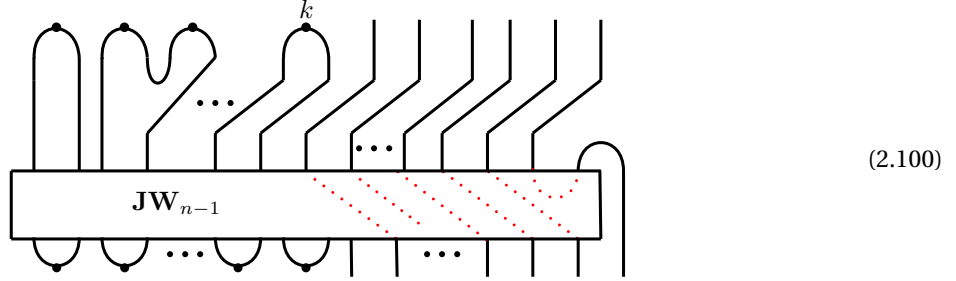

and are all equal to  $x\beta'_{k,\lambda}$  where  $\beta'_{k,\lambda}$  is as before in (2.98). Finally, for  $j = 2k$  there is no contribution since the corresponding diagram is as follows

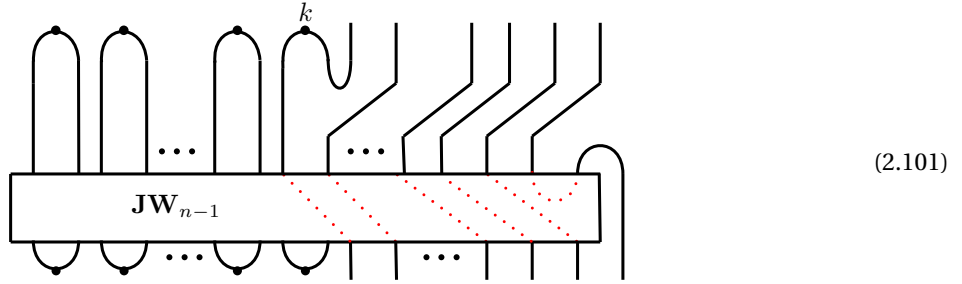

Summing up and taking into account the coefficients  $\frac{j}{n}$  appearing in (2.93) we get from all this that

$$\beta_{k,\lambda} = \beta_{k,\lambda-1} + k \frac{(k-1)x + ky}{n} \beta'_{k,\lambda} = \beta_{k,\lambda-1} + \frac{k}{n} \alpha_{y,k} \beta'_{k,\lambda}. \quad (2.102)$$

We are therefore faced with the problem of calculating  $\beta'_{k,\lambda}$ , that is

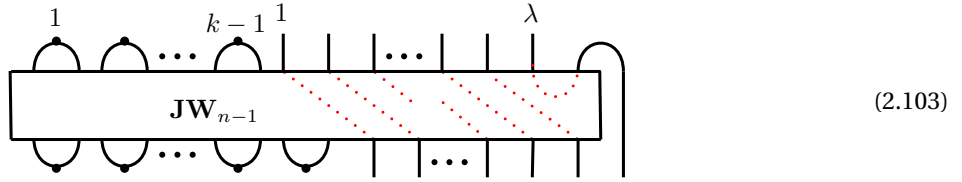

For this we first observe that by the symmetry properties of the Jones-Wenzl idempotents, we have that  $\beta'_{k,\lambda}$  is equal to

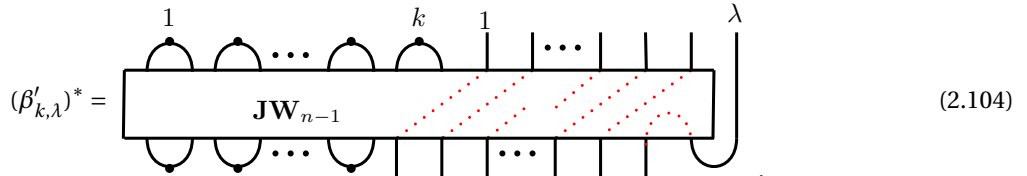

We now expand  $\mathbf{JW}_{n-1}$  in (2.104) using (2.93). The first term of (2.93) does not contribute to (2.104) so let us consider the contribution of the  $j$ 'th term of the sum of (2.93), where arguing as in (2.95) we see that only  $j \leq 2k$  can contribute. Once again, there is a dependency on the parity of  $j$ . If  $j = 1, 3, \dots, 2k-1$  the contributions are of



the form indicated below (for  $j = 1, 3$  and disregarding the coefficients)

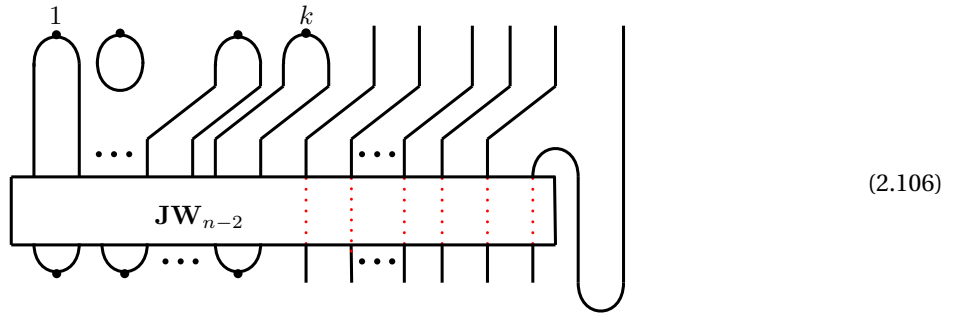
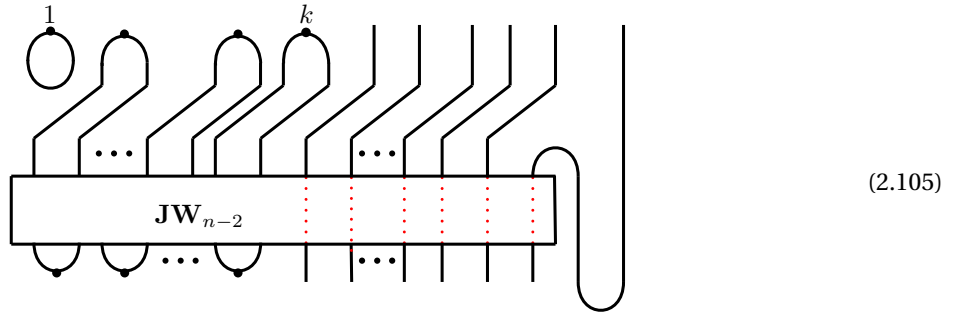

and are in fact all equal to  $y\beta_{k-1,\lambda}$ . Similarly, for  $j = 2, 4, \dots, 2k-2$  we get contributions of the form

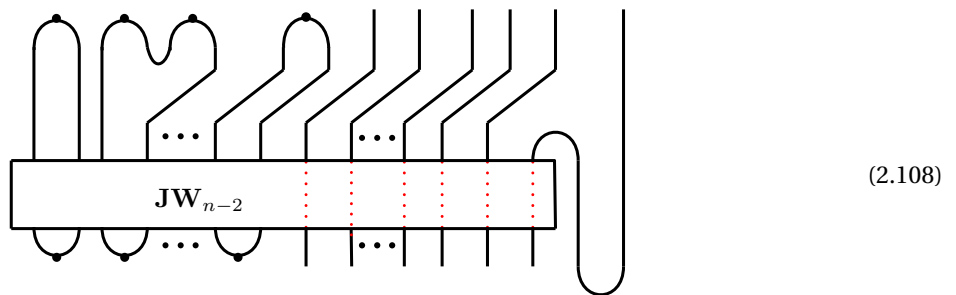
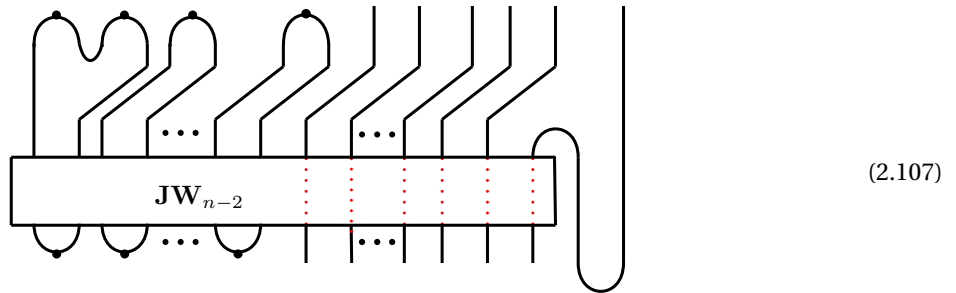

all equal to  $x\beta_{k-1,\lambda}$ . Once again, there is no contribution for  $j = 2k$ . Hence, taking into account the coefficients  $\frac{j}{n-1}$ , we get that

$$\beta'_{k,\lambda} = \frac{k}{n-1} \alpha_{y,k} \beta_{k-1,\lambda}. \quad (2.109)$$

Combining (2.109) and (2.102) we arrive at the promised recursive formula (2.88) for the  $\beta_{k,\lambda}$ 's. This proves **a)**. The proof of **b)** is immediate from **a)** and the definitions.  $\square$

Using Theorem 2.4.1 we can now calculate the matrix  $M_{n,\lambda}^{\mathbb{B}}$  for  $\langle \cdot, \cdot \rangle_{n,\lambda}^{\mathbb{B}}$ , see (2.80). We illustrate it on  $M_{5,1}^{\mathbb{B}}$ . Recall that the diagram basis for  $\Delta_5^{\mathbb{B}}(1)$  is given in (2.55) and so we get from the Theorem that

$$M_{5,1}^{\mathbb{B}} = \begin{pmatrix} I_5 & 0 & 0 \\ 0 & \alpha_{x,3}\alpha_{y,1}I_4 & 0 \\ 0 & 0 & \alpha_{x,3}\alpha_{x,4}\alpha_{y,1}\alpha_{y,2}I_1 \end{pmatrix} \quad (2.110)$$

where the 0's are 0-matrices of appropriate dimensions.

We now consider the situation where  $\lambda < 0$ . We have the following Theorem.

THEOREM 2.4.2.

- a) Suppose that  $\lambda < 0$  and that  $f_i^\lambda$  is as in (2.64) but with  $j = 0$ , that is  $f_i^\lambda = f_k^\lambda$  where

$$f_k^\lambda = \begin{array}{c} \begin{array}{ccccccc} & 1 & 2 & \dots & k & 1 & 2 & \dots & |\lambda| \\ & \frown & \frown & & \frown & | & | & & | \\ & & & & & & & & \\ \text{---} & & & & & & & & \\ & & & & & & & & \\ & 1 & 2 & \dots & & & & \dots & n \end{array} \\ \text{---} \\ \text{---} \end{array} \quad \text{JW}_n \quad (2.111)$$

Then we have that

$$\langle f_k^\lambda, f_k^\lambda \rangle_{n,\lambda}^{\mathbb{B}} = \frac{1}{\binom{n}{k}} (\alpha_{x,1}\alpha_{x,2}\cdots\alpha_{x,k+1})\alpha_{y,1+|\lambda|}\alpha_{y,2+|\lambda|}\cdots\alpha_{y,k+|\lambda|} \quad (2.112)$$

where  $n = 2k + |\lambda|$ . (Note that the right hand side of (2.84) contains  $k + 1$  factors  $\alpha_{x,l}$  for consecutive  $l$ 's, but  $k$  factors  $\alpha_{y,l}$ , for consecutive  $l$ 's. For  $k = 0$ , it is set equal to  $\alpha_{x,1} = x$ . Note also that  $\binom{n}{k} = \dim \Delta_n^{\mathbb{B}}(\lambda)$ .)

- b) Let  $c_i(x, y)$  be as in (2.78) and (2.80). Then up to multiplication by a nonzero scalar in  $\mathbb{C}$ , we have that

$$c_i(x, y) = (\alpha_{x,1}\alpha_{x,2}\cdots\alpha_{x,i+1})\alpha_{y,1+|\lambda|}\alpha_{y,2+|\lambda|}\cdots\alpha_{y,i+|\lambda|} \quad (2.113)$$

(where, as before, the product is set equal to  $x$  if  $i = 0$ ).

*Proof:* The proof is essentially the same as the proof of Theorem 2.4.1. We leave the details to the reader.  $\square$

Let us illustrate Theorem 2.4.2 on  $M_{5,-1}^{\mathbb{B}}$  and  $M_{5,-3}^{\mathbb{B}}$ . Recall that the diagram basis for  $\Delta_5^{\mathbb{B}}(-1)$  is obtained from (2.55) by marking the leftmost propagating line of each diagram, whereas the diagram basis for  $\Delta_5^{\mathbb{B}}(-3)$  is given in (2.56). We have

$$M_{5,-1}^{\mathbb{B}} = \begin{pmatrix} \alpha_{x,1}I_5 & 0 & 0 \\ 0 & \alpha_{x,1}\alpha_{x,2}\alpha_{y,2}I_4 & 0 \\ 0 & 0 & \alpha_{x,1}\alpha_{x,2}\alpha_{x,3}\alpha_{y,2}\alpha_{y,3}I_1 \end{pmatrix}, \quad M_{5,-3}^{\mathbb{B}} = \begin{pmatrix} \alpha_{x,1}I_4 & 0 \\ 0 & \alpha_{x,1}\alpha_{x,2}\alpha_{y,4}I_1 \end{pmatrix}. \quad (2.114)$$

### 5. Characterization of $c_i(x, y)$ in terms of Bruhat order on $W$

We saw in the Theorems 2.4.1 and 2.4.2 that  $c_i(x, y)$  has a factorization in terms of roots for  $W$ . In this section we describe the reflections in  $W$  that correspond to these roots. It turns out that these reflections can be described nicely in terms of the Bruhat order on  $W$ .

Let  $\beta = w\alpha$  be a root for  $W$  where  $\alpha$  is a simple root. Then we define the *reflection*  $s_\beta \in W$  associated with  $\beta$  via the formula

$$s_\beta := ws_\alpha w^{-1} \quad (2.115)$$

where  $s_\alpha \in S$  is the generator associated with  $\alpha$ . It is shown in section 5.7 of [21] that  $s_\beta$  only depends on  $\beta$ , not on the particular choices of  $w$  and  $\alpha$  such that  $\beta = w\alpha$ .

For our  $W$ , the reflections  $s_{x,i}$  and  $s_{y,i}$  for the roots  $\alpha_{x,i}$  and  $\alpha_{y,i}$  are given by the formulas of the following Lemma.

LEMMA 2.5.1. Let  $\alpha_{x,i}$  and  $\alpha_{y,i}$  be the positive roots for  $W$  introduced in (2.81) and let  $s_{x,i}$  and  $s_{y,i}$  be the associated reflections, for  $i = 1, 2, \dots$ . Then we have that

$$s_{x,i} = (st)^{i-1}s, \quad s_{y,i} = t(st)^{i-1}. \quad (2.116)$$

PROOF. This is immediate from (2.81) and the definitions.  $\square$

We now have the following Lemma.

LEMMA 2.5.2. *Let  $v \in \Lambda_w$  and let  $\lambda := \varphi(v) \in \Lambda_{\pm(n-1)}$  where  $\varphi : \Lambda_w \rightarrow \Lambda_{\pm(n-1)}$  is the function defined in Lemma 2.2.5. Set  $k = \frac{n-1-|\lambda|}{2}$ .*

a) *Suppose that  $\lambda \geq 0$ . Then the set of reflections  $s_\alpha$  in  $W$  satisfying  $v < s_\alpha v \leq w$  is exactly*

$$\{s_{x,\lambda+2}, s_{x,\lambda+3}, \dots, s_{x,\lambda+k+1}\} \cup \{s_{y,1}, s_{y,2}, \dots, s_{y,k}\} \quad (2.117)$$

*obtained by transforming the roots of the factors of (2.84) to reflections.*

b) *Suppose that  $\lambda < 0$ . Then the set of reflections  $s_\alpha$  in  $W$  satisfying  $v < s_\alpha v \leq w$  is exactly*

$$\{s_{x,1}, s_{x,2}, \dots, s_{x,k+1}\} \cup \{s_{y,1+|\lambda|}, s_{y,2+|\lambda|}, \dots, s_{y,k+|\lambda|}\} \quad (2.118)$$

*obtained by transforming the roots of the factors of (2.112) to reflections.*

PROOF. Let us prove a). Since  $\lambda \geq 0$  we have that  $v$  begins with  $s$  and that  $\lambda = l(v) - 1$ . Viewing  $v$  as a 'tail' of  $w$ , see (2.45), there are  $k$  instances in  $w$  of  $s$  to the left of  $v$  and also  $k$  instances of  $t$  to the left of  $v$ . Multiplying  $v$  on the right of the reflections  $s_{y,1}, s_{y,2}, \dots, s_{y,k}$  gives the tails from these  $t$ 's, as illustrated below in (2.119) for  $n = 20$  and  $\lambda = 9$

(2.119)

and multiplying  $v$  on the right of the reflections  $s_{x,\lambda+2}, s_{x,\lambda+3}, \dots, s_{x,\lambda+k+1}$ , gives the tails from the  $s$ 's, upon deleting the last generator of  $w$ , as illustrated below

(2.120)

These products all satisfy the conditions  $v < s_\alpha v \leq w$  of the Lemma, and one also checks that they are the only ones satisfying the conditions. This shows a), and b) is shown the same way.  $\square$

## 6. Graded Jantzen filtrations and sum formulas

In this final section we study the representation theory of  $\tilde{A}_w$  and its specialization  $\tilde{A}_w^{\mathbb{C}} := \tilde{A}_w \otimes_R \mathbb{C}$ , where the  $R$ -algebra structure on  $\mathbb{C}$  is given by mapping  $\alpha_s^{\vee}$  and  $\alpha_t^{\vee}$  to 0. Note that  $\tilde{A}_w^{\mathbb{C}}$  has already been studied in the literature, in fact for general  $(W, S)$  for example in [44] or in [40].

As already mentioned,  $\tilde{A}_w$  is a cellular algebra and hence also  $\tilde{A}_w^{\mathbb{C}}$  is a cellular algebra, with cell modules  $\Delta_w^{\mathbb{C}}(y) := \Delta_w(y) \otimes_R \mathbb{C}$  for  $y \in \tilde{\Lambda}_w$ . Moreover, as already indicated,  $\tilde{A}_w$  and  $\tilde{A}_w^{\mathbb{C}}$  are  $\mathbb{Z}$ -graded algebras with degree function  $\deg$  given in (1.4.2). In fact they are *graded* cellular algebras, that is they fit into the following definition first formulated by Hu and Mathas, see [20].

DEFINITION 2.6.1. *Suppose that  $\mathbb{k}$  is a commutative ring with identity and that  $\mathcal{A}$  is a  $\mathbb{k}$ -algebra which is cellular on the triple  $(\Lambda, \text{Tab}, \mathbb{C})$ . Suppose moreover that  $\mathcal{A}$  is a  $\mathbb{Z}$ -graded algebra via  $\mathcal{A} = \bigoplus_{i \in \mathbb{Z}} \mathcal{A}_i$ . Then we say that  $\mathcal{A}$  is a  $\mathbb{Z}$ -graded cellular algebra if for each  $\lambda \in \Lambda$  there is a function  $\deg : \text{Tab}(\lambda) \rightarrow \mathbb{Z}$  such that for  $s, t \in \text{Tab}(\lambda)$  we have that  $C_{st} \in \mathcal{A}_{\deg(s)+\deg(t)}$ .*

We shall in general refer to  $\mathbb{Z}$ -graded cellular algebras simply as *graded cellular algebras*.

The same degree function  $\deg$  that was used for  $\tilde{A}_w$  also makes  $A_w$  and  $A_w^{\mathbb{C}}$  into  $\mathbb{Z}$ -graded cellular algebras. On the other hand, to make the blob-algebras  $\mathbb{B}_n^{x,y}$  and  $\mathbb{N}\mathbb{B}_n$  fit into Definition 2.6.1 we use the function  $\deg : \text{Tab}(\lambda) \rightarrow \mathbb{Z}$  given by

$$\deg(t) : \text{Tab}(\lambda) \rightarrow \mathbb{Z}, \deg(t) = \begin{cases} 2\{\text{number of blobs in } t\} & \text{if } \lambda \geq 0 \\ 2\{\text{number of blobs in } t\} + 1 & \text{if } \lambda < 0 \end{cases} \quad (2.121)$$

where  $\text{Tab}(\lambda)$  refers to blob half-diagrams as in the paragraph prior to equation (2.16). Thus, when viewing  $\text{Tab}(\lambda)$  as the basis elements for  $\Delta_n^{\mathbb{B}}(\lambda)$  as in (2.55) and (2.56), the function  $\deg$  assigns degree 1 to a blob on a propagating line, and degree 2 to a blob on a non-propagating line.

For  $\mathcal{A}$  a graded cellular algebra over  $\mathbb{k}$  we let  $\mathcal{A}\text{-mod}$  be the category of  $\mathcal{A}$ -modules which are free over  $\mathbb{k}$  with finite basis consisting of homogeneous elements. For  $M$  in  $\mathcal{A}\text{-mod}$  we define its *graded rank*  $\text{rk}_q M \in \mathbb{Z}[q, q^{-1}]$  via

$$\text{rk}_q M := \sum_{i \in \mathbb{Z}} \text{rk } M_i q^i \quad (2.122)$$

where  $\text{rk } M_i$  is the number of basis elements for  $M$  that have degree  $i$ .

We shall use the notation  $\tilde{A}_w^{gr}$  and  $\tilde{A}_w^{gr, \mathbb{C}}$  when referring to  $\tilde{A}_w$  and  $\tilde{A}_w^{\mathbb{C}}$  as graded cellular algebras and similarly, for  $v \in \tilde{\Lambda}_w$ , we shall use the notation  $\Delta_w^{gr}(v)$  and  $\Delta_w^{gr, \mathbb{C}}(v)$  for the graded cell modules for  $\tilde{A}_w^{gr}$  and  $\tilde{A}_w^{gr, \mathbb{C}}$ . On the blob-algebra side, we shall use the notation  $\mathbb{B}_n^{gr, x, y}$  and  $\mathbb{N}\mathbb{B}_n^{gr}$  for  $\mathbb{B}_n^{x, y}$  and  $\mathbb{N}\mathbb{B}_n$ , when viewed as graded cellular algebras, and shall for  $\lambda \in \Lambda_{\pm n}$  use the notation  $\Delta_n^{gr, \mathbb{B}}(\lambda)$  and  $\Delta_n^{gr, \mathbb{B}, \mathbb{C}}(\lambda)$  for the graded cell modules for  $\mathbb{B}_n^{gr, x, y}$  and  $\mathbb{N}\mathbb{B}_n^{gr}$ .

The proof of Theorem mainTheoremSection3new shows that  $\mathbb{B}_{n-1}^{gr, x, y} \cong A_w^{gr}$  and so also  $\mathbb{N}\mathbb{B}_{n-1}^{gr} \cong A_w^{gr, \mathbb{C}}$ . Recall the map  $\varphi : \Lambda_{\pm(n-1)} \rightarrow \Lambda_w$  from Lemma 2.2.5. Then, similarly, the proof of Theorem 2.2.7 shows that  $\Delta_{n-1}^{gr, \mathbb{B}}(\lambda) \cong \Delta_w^{gr}(v)$  where  $\varphi(\lambda) = v$  and so also  $\Delta_{n-1}^{gr, \mathbb{B}, \mathbb{C}}(\lambda) \cong \Delta_w^{gr, \mathbb{C}}(v)$ . However, for  $v$  not belonging to the image of  $\varphi$ , that is for  $v \in \Lambda_w^c$ , see (2.47), we need to work a little bit to get an analogous description of  $\Delta_w^{gr}(v)$  and  $\Delta_w^{gr, \mathbb{C}}(v)$ .

For  $\mathcal{A}$  a graded cellular algebra and  $M = \oplus_{i \in \mathbb{Z}} M_i$  a graded  $\mathcal{A}$ -module we define the *graded shift*  $M[k]$  of  $M$  as the graded  $\mathcal{A}$ -module given by

$$M[k] = \oplus_{i \in \mathbb{Z}} M[k]_i \text{ where } M[k]_i := M_{i-k}. \quad (2.123)$$

The first part of the following Lemma has just been mentioned, but we still include it for later reference. The second part of the Lemma essentially says that the  $v$ 's in  $\Lambda_w^c$  do not give rise to 'new' cell modules for  $A_w^{gr}$ .

LEMMA 2.6.2. *Suppose that  $\underline{w} = \underline{w}_1 s'$ , that is  $s'$  is the last  $S$ -generator of  $\underline{w}$ .*

- For  $v = \varphi(\lambda)$  we have that  $\Delta_w^{gr}(v) \cong \Delta_{n-1}^{gr, \mathbb{B}}(\lambda)$ .
- For  $v \in \Lambda_w^c$  set  $v_1 := v s'$ , that is  $l(v_1) = l(v) + 1$ . Then  $\Delta_w^{gr}(v) \cong \Delta_w^{gr}(v_1)[1] \cong \Delta_{n-1}^{gr, \mathbb{B}}(\lambda)[1]$  where  $\varphi(\lambda) = v_1$ .

*Proof:* As mentioned, we only need to prove b). Let  $D_1$  be the following diagram

$$D_1 := \begin{array}{c} \begin{array}{ccc} \text{┌} & v & \text{┐} \\ | & & | \\ | & \cdots & | \\ | & & | \\ \text{└} & v_1 & \text{┘} \end{array} \end{array} \quad (2.124)$$

(where we suppose that  $s'$  is blue). For any diagram  $D$  for  $\Delta_w^{gr}(v_1)$ , we define  $f(D) := DD_1$ , that is  $f(D)$  is obtained from  $D$  by multiplying on top with  $D_1$ . Then  $f$  induces an  $R$ -isomorphism  $\Delta_w(v_1) \cong \Delta_w(v)$  which is also a module isomorphism since left multiplication commutes with right multiplication. But  $D_1$  is of degree 1, and so we get that  $f : \Delta_w^{gr}(v_1) \rightarrow \Delta_w^{gr}(v)[-1]$  and hence  $\Delta_w^{gr}(v_1)[1] \cong \Delta_w^{gr}(v)$ . Combining this with a) we obtain b).  $\square$

LEMMA 2.6.3.

a) Suppose that  $\lambda \in \Lambda_{\pm(n-1)}$  with  $\lambda \geq 0$ . Then

$$\mathrm{rk}_q \Delta_{n-1}^{gr, \mathbb{B}}(\lambda) = \mathrm{rk}_q \Delta_{n-1}^{gr, \mathbb{B}, \mathbb{C}}(\lambda) = \sum_{i=0}^{\frac{n-1-\lambda}{2}} \mathrm{rk} \Delta_{n-1}^{\mathbb{T}\mathbb{L}}(\lambda + 2i) q^{2i}. \quad (2.125)$$

b) Suppose that  $\lambda \in \Lambda_{\pm(n-1)}$  with  $\lambda < 0$ . Then

$$\mathrm{rk}_q \Delta_{n-1}^{gr, \mathbb{B}}(\lambda) = \mathrm{rk}_q \Delta_{n-1}^{gr, \mathbb{B}, \mathbb{C}}(\lambda) = q \mathrm{rk}_q \Delta_{n-1}^{gr, \mathbb{B}}(-\lambda). \quad (2.126)$$

*Proof:* This follows immediately from Lemma 2.3.1.  $\square$

For  $\lambda \in \Lambda_{\pm(n-1)}$  let  $\{b_1, b_2, \dots, b_m\}$  be the  $R$ -basis for  $\Delta_{n-1}^{\mathbb{B}}(\lambda)$  obtained from (2.80) and Theorem 2.4.1 if  $\lambda \geq 0$  or from Theorem 2.4.2 if  $\lambda < 0$ . According to these Theorems  $\langle b_i, b_i \rangle_{n-1, \lambda}^{\mathbb{B}}$  is a product of positive roots for  $W$  and so  $\{b_1, b_2, \dots, b_m\}$  consists of homogeneous elements since  $\langle \cdot, \cdot \rangle_{n-1, \lambda}^{\mathbb{B}}$  is homogeneous. The degree of  $b_i$  is equal to number of roots appearing in  $\langle b_i, b_i \rangle_{n-1, \lambda}^{\mathbb{B}}$  according to Theorem 2.4.1 and 2.4.2.

Let now  $\alpha$  be a positive root for  $W$ . We then introduce the following  $\mathbb{B}_n^{gr, x, y}$ -submodule of  $\Delta_{n-1}^{gr, \mathbb{B}}(\lambda)$

$$\Delta_{n-1}^{gr, \alpha}(\lambda) := \{a \in \Delta_{n-1}^{gr, \mathbb{B}}(\lambda) \mid \alpha \text{ divides } \langle a, b \rangle_{n-1, \lambda}^{\mathbb{B}} \text{ for all } b \in \Delta_{n-1}^{gr, \mathbb{B}}(\lambda)\}. \quad (2.127)$$

From the above remarks we have that  $\Delta_{n-1}^{gr, \alpha}(\lambda)$  is a free over  $R$  with basis

$$\{b_i \mid \alpha \text{ is a factor of } \langle b_i, b_i \rangle_{n-1, \lambda}^{\mathbb{B}}\}. \quad (2.128)$$

The proof of the following Theorem is a compilation of the results from the previous sections.

**THEOREM 2.6.4.** *Supposing that  $v = \varphi(\lambda)$  and that  $v < s_\alpha v \leq w$  we have that*

$$\mathrm{rk}_q \Delta_{n-1}^{gr, \alpha}(\lambda) = \mathrm{rk}_q \Delta_w^{gr} (s_\alpha v) [l(s_\alpha v) - l(v)]. \quad (2.129)$$

*Otherwise, if  $v < s_\alpha v \leq w$  is not satisfied, we have  $\Delta_{n-1}^{gr, \alpha}(\lambda) = 0$ .*

*Proof:* Let  $k := \frac{n-1-\lambda}{2}$ . Let us first consider the case where  $\lambda \geq 0$  and  $\alpha = \alpha_{y, i}$  for some  $i = 1, 2, \dots, k$ , hence  $s_\alpha = t(st)^{i-1}$ , see Lemma 2.116. By Lemma 2.6.2 we have that  $\Delta_{n-1}^{gr, \mathbb{B}}(\lambda) \cong \Delta_w^{gr}(v)$ . The distinct roots  $\alpha_{x, j}$  and  $\alpha_{y, j}$  are irreducible and unassociated elements of  $R$  and so it follows from the description in Theorem 2.4.1 of the matrix  $M_{n-1, \lambda}^{\mathbb{B}}$  in (2.80) that

$$\mathrm{rk}_q \Delta_{n-1}^{gr, \alpha}(\lambda) = \sum_{j=i}^k \mathrm{rk} \Delta_{n-1}^{\mathbb{T}\mathbb{L}}(\lambda + 2j) q^{2j} = q^{2i} \sum_{j=0}^{k-i} \mathrm{rk} \Delta_{n-1}^{\mathbb{T}\mathbb{L}}(\lambda + 2i + 2j) q^{2j}. \quad (2.130)$$

Using Lemma 2.6.3 and Lemma 2.2.5 we get that (2.130) is equal to

$$q^{2i} \mathrm{rk}_q \Delta_{n-1}^{gr, \mathbb{B}}(\lambda + 2i) = q^{2i-1} \mathrm{rk}_q \Delta_{n-1}^{gr, \mathbb{B}}(-\lambda - 2i) = q^{2i-1} \mathrm{rk}_q \Delta_w^{gr} (t(st)^{i-1} v) = q^{2i-1} \mathrm{rk}_q \Delta_w^{gr} (s_\alpha v). \quad (2.131)$$

But  $v$  begins with  $s$  since  $\lambda \geq 0$  and so the last expression of (2.131) is  $\mathrm{rk}_q \Delta_w^{gr} (s_\alpha v) [l(s_\alpha v) - l(v)]$  which shows the Theorem in this case. For an illustration of  $s_\alpha v$ , see (2.119).

Let us now consider the case where still  $\lambda \geq 0$ , but  $\alpha = \alpha_{x, \lambda+1+i}$  and hence  $s_\alpha = (st)^{\lambda+i} s$ , see Lemma 2.116. Then  $\alpha$  appears in the same blocks as  $\alpha_{y, i}$  did in the previous case, and so we get from (2.130) and (2.131) that

$$\mathrm{rk}_q \Delta_{n-1}^{gr, \alpha}(\lambda) = q^{2i-1} \mathrm{rk}_q \Delta_w^{gr} (t(st)^{i-1} v) = q^{2i} \mathrm{rk}_q \Delta_w^{gr} ((st)^i v) \quad (2.132)$$

where we used Lemma 2.2.5 and b) of Lemma 2.6.3 for the second equality. On the other hand, writing  $v = us'$  with  $l(u) + 1 = l(v)$  we get from Lemma 2.5.2 and b) of Lemma 2.6.2 that

$$\mathrm{rk}_q \Delta_w^{gr} (s_\alpha v) = \mathrm{rk}_q \Delta_w^{gr} ((st)^i u) = q \mathrm{rk}_q \Delta_w^{gr} ((st)^i v). \quad (2.133)$$

Comparing (2.132) and (2.133) we get

$$\mathrm{rk}_q \Delta_{n-1}^{gr, \alpha}(\lambda) = q^{2i-1} \mathrm{rk}_q \Delta_w^{gr} (s_\alpha v) = \mathrm{rk}_q \Delta_w^{gr} (s_\alpha v) [l(s_\alpha v) - l(v)] \quad (2.134)$$

which shows the Theorem in this case as well. The remaining cases of the Theorem are proved with similar techniques.  $\square$

Our next aim is to generalize Theorem 2.6.4 to  $\Delta_w^{gr}(v)$ . This is immediate if  $v \in \Lambda_w$  since in that case  $v \in im\varphi$ , whereas for  $v \in \Lambda_w^c$  we have to work a little bit. For  $\alpha$  a positive root we first generalize (2.127) in order to get a graded submodule  $\Delta_w^{gr,\alpha}(v)$  of  $\Delta_w^{gr}(v)$ .

$$\Delta_w^{gr,\alpha}(v) := \{a \in \Delta_w^{gr}(v) \mid \alpha \text{ divides } \langle a, b \rangle_{n,v}^w \text{ for all } b \in \Delta_w^{gr}(v)\}. \quad (2.135)$$

We then have the following Theorem.

**THEOREM 2.6.5.** *Let  $\alpha$  be a positive root for  $W$ . If  $v < s_\alpha v \leq w$  then*

$$\text{rk}_q \Delta_w^{gr,\alpha}(v) = \text{rk}_q \Delta_w^{gr}(s_\alpha v) [l(s_\alpha v) - l(v)] \quad (2.136)$$

and otherwise  $\Delta_w^{gr,\alpha}(v) = 0$ .

*Proof:* As already mentioned, if  $v \in \Lambda_w$  the result follows immediately from Theorem 2.6.4, so let us assume that  $v \in \Lambda_w^c$ . As before we write  $\underline{w} = \underline{w}_1 s'$ , where  $s'$  is the last  $S$ -generator of  $\underline{w}$  and set  $v_1 = v s'$ . Then  $l(v_1) = l(v) + 1$  and  $v_1 \in \Lambda_w$ . Let  $D$  be a diagram basis element for  $\Delta_w(v)$ . Then  $D$  has nonempty zone  $C$  and we define  $D_1$  to be the diagram basis element for  $\Delta_w(v_1)$  which is obtained from  $D$  by making the last non-hanging birdcage, corresponding to zone  $C$ , hanging. Then  $D \mapsto D_1$  is a bijection between the diagram basis for  $\Delta_w(v)$  and the diagram basis for  $\Delta_w(v_1)$ . On the other hand, using the definition of the bilinear forms we have that

$$\langle D, C \rangle_{n,v}^w = v(\alpha') \langle D_1, C_1 \rangle_{n,v_1}^w \quad (2.137)$$

where  $\alpha'$  is the root corresponding to  $s'$  and so the matrix for  $\langle \cdot, \cdot \rangle_{n,v}^w$  has the diagonalized form  $v(\alpha') M_{n-1,\lambda}^{\mathbb{B}}$  where  $\lambda = \varphi(v_1)$ . We now assume that  $\lambda \geq 0$  such that  $M_{n-1,\lambda}^{\mathbb{B}}$  is given by Theorem 2.4.1. One then checks that  $v(\alpha') = \alpha_{x,\lambda+1}$ . Moreover, the set of reflections  $s_\alpha$  in  $W$  satisfying  $v < s_\alpha v \leq w$  is the union of  $s_{x,\lambda+1}$  with the set of reflections  $s_\alpha$  satisfying  $v_1 < s_\alpha v_1 \leq w$ , and hence, in view of Lemma 2.5.2, it is equal to

$$\{s_{x,\lambda+1}, s_{x,\lambda+2}, s_{x,\lambda+3}, \dots, s_{x,\lambda+k+1}\} \cup \{s_{y,1}, s_{y,2}, \dots, s_{y,k}\} \quad (2.138)$$

which is exactly the set of reflections obtained by transforming the roots of the factors of the diagonal elements of  $v(\alpha') M_{n-1,\lambda}^{\mathbb{B}}$  to reflections.

Let us now show (2.136). If  $\alpha$  is a factor of a diagonal element of  $M_{n-1,\lambda}^{\mathbb{B}}$  we are reduced to the previous case treated in Theorem 2.6.4, as follows

$$\text{rk}_q \Delta_w^{gr,\alpha}(v) = q \text{rk}_q \Delta_{n-1}^{gr,\alpha}(\lambda) = q \text{rk}_q \Delta_w^{gr}(s_\alpha v_1) [l(s_\alpha v_1) - l(v_1)] = \text{rk}_q \Delta_w^{gr}(s_\alpha v) [l(s_\alpha v) - l(v)] \quad (2.139)$$

where we used Lemma 2.6.2 for the last step. On the other hand, if  $\alpha = \alpha_{x,\lambda+1}$  we have that  $s_\alpha v_1 = v$  and so we get

$$\text{rk}_q \Delta_w^{gr,\alpha}(v) = q \text{rk}_q \Delta_{n-1}^{gr}(\lambda) = \text{rk}_q \Delta_w^{gr}(s_\alpha v_1) [l(s_\alpha v_1) - l(v_1)] \quad (2.140)$$

which shows (2.136) in this case as well. The cases where  $\lambda < 0$  are treated with similar techniques.  $\square$

$\Delta_w^{gr,\alpha}(v)$  is free over  $R$  and hence we get immediately a specialized version of Theorem 2.6.5.

**COROLLARY 2.6.6.** *Defining  $\Delta_w^{gr,\alpha,\mathbb{C}}(v) := \Delta_w^{gr,\alpha}(v) \otimes_R \mathbb{C}$  we have that*

$$\text{rk}_q \Delta_w^{gr,\alpha,\mathbb{C}}(v) = \text{rk}_q \Delta_w^{gr,\mathbb{C}}(s_\alpha v) [l(s_\alpha v) - l(v)]. \quad (2.141)$$

The definition of  $\Delta_w^{gr,\alpha}(v)$  in (2.135) is reminiscent of the Jantzen filtration for Verma modules. To make this analogy even stronger we let  $R_1 := \mathbb{C}[\mathbf{x}]$  and define  $\Delta_w^{gr,\mathbf{x}}(v) := \Delta_w^{gr}(v) \otimes_R R_1$  where  $R_1$  is made into an  $R$ -module via  $\alpha_s \mapsto \mathbf{x}$  and  $\alpha_t \mapsto \mathbf{x}$ . Then  $\{\Delta_w^{gr,\mathbf{x}}(v) \mid v \in \tilde{\Lambda}_w\}$  are graded cell modules for  $\tilde{A}_w^{gr,\mathbf{x}} := \tilde{A}_w^{gr} \otimes_R R_1$ . In  $R_1$  all the roots  $\alpha_{x,i}$  and  $\alpha_{y,i}$  are non-zero scalar multiples of  $\mathbf{x}$  and so we define for any  $k = 1, 2, \dots$

$$\Delta_w^{gr,k,\mathbf{x}}(v) := \{a \in \Delta_w^{gr,\mathbf{x}}(v) \mid \mathbf{x}^k \text{ divides } \langle a, b \rangle_{n,v}^w \text{ for all } b \in \Delta_w^{gr,\mathbf{x}}(v)\} \quad (2.142)$$

$$\Delta_w^{gr,k,\mathbb{C}}(v) := \pi(\Delta_w^{gr,k,\mathbf{x}}(v)) \quad (2.143)$$

where  $\pi : \Delta_w^{gr,\mathbf{x}}(v) \rightarrow \Delta_w^{gr,\mathbf{x}}(v) \otimes_R \mathbb{C}$  is the quotient map: here  $\mathbb{C}$  is made into an  $R_1$ -module via  $\mathbf{x} \mapsto 0$ . Then  $\Delta_w^{gr,\mathbb{C}}(v) \supseteq \Delta_w^{gr,1,\mathbb{C}}(v) \supseteq \Delta_w^{gr,2,\mathbb{C}}(v) \supseteq \dots$  is a filtration of graded submodules of  $\Delta_w^{gr,\mathbb{C}}(v)$  and we have the following Corollary to Theorem 2.6.5.

**COROLLARY 2.6.7.**

- a)  $\Delta_w^{gr,\mathbb{C}}(v) / \Delta_w^{gr,1,\mathbb{C}}(v)$  is irreducible or zero.

b) *The following graded analogue of Jantzen's sum formula holds*

$$\sum_{k>0} \text{rk}_q \Delta_w^{gr,k,C}(v) = \sum_{\substack{\alpha>0 \\ v < s_\alpha v \leq w}} \text{rk}_q \Delta_w^{gr,C}(s_\alpha v) [l(s_\alpha v) - l(v)] \quad (2.144)$$

where  $\alpha > 0$  refers to the positive roots of  $W$ .

As pointed out in the introduction, analogues of ungraded Jantzen filtrations with associated sum formulas exist in many module categories of Lie type and give information on the irreducible modules for the category in question. But although graded representation theories in Lie theory have been known for a long time and would be very useful for calculating decomposition numbers, to our knowledge graded sum formulas have so far not been available. The virtue of Corollary 2.6.7 is to show the possible form of graded sum formulas in graded representation theory.

It should be noted that in the present  $\mathbb{N}\mathbb{B}_n$ -situation, the irreducible modules can be read off from Theorem 2.4.1 and Theorem 2.4.2 and are in fact Temperley-Lieb cell modules. See also [39] for a different approach to this.

We believe that the equalities in Theorem 2.6.5 and Corollary 2.6.6 are valid on module level, but have so far not been able to prove so. But in the remainder of the article we indicate how to generalize them to *enriched* Grothendieck group level. The methods for this are essentially generalizations to the graded case of the methods in [44], where the corresponding ungraded case is treated.

Let  $\mathcal{A}$  be a graded cellular algebra over  $\mathbb{C}$ . Let  $\langle \mathcal{A}\text{-mod} \rangle_q$  be the *enriched* Grothendieck group for  $\mathcal{A}$ , that is  $\langle \mathcal{A}\text{-mod} \rangle_q$  is the Abelian group generated by symbols  $\langle M \rangle_q$ , for  $M$  running over the modules in  $\langle \mathcal{A}\text{-mod} \rangle_q$ , subject to the relations  $\langle M \rangle_q = \langle M_1 \rangle_q + \langle M_2 \rangle_q$  whenever there is a short exact sequence  $0 \rightarrow M_1 \rightarrow M \rightarrow M_2 \rightarrow 0$  in  $\langle \mathcal{A}\text{-mod} \rangle_q$ . The grading shift in  $\mathcal{A}\text{-mod}$  induces a grading shift in  $\langle \mathcal{A}\text{-mod} \rangle_q$  via  $\langle M \rangle_q[k] := \langle M[k] \rangle_q$  and so we get a  $\mathbb{Z}[q, q^{-1}]$ -structure on  $\mathcal{A}\text{-mod}$  via  $\langle M \rangle_q + \langle N \rangle_q := \langle M \oplus N \rangle_q$  and  $q^k \langle M \rangle_q := \langle M \rangle_q[k]$ .

The following is a natural generalization of the definition of a cellular category, see [50], to the  $\mathbb{Z}$ -graded case.

DEFINITION 2.6.8. *Let  $\mathbb{k}$  be a commutative ring with identity and let  $\mathcal{C}$  be a  $\mathbb{k}$ -linear  $\mathbb{Z}$ -graded category, that is for objects  $m, n$  in  $\mathcal{C}$  we have a decomposition*

$$\text{Hom}_{\mathcal{C}}(m, n) = \oplus_{i \in \mathbb{Z}} \text{Hom}_{\mathcal{C}}(m, n)_i \quad (2.145)$$

Suppose that  $\mathcal{C}$  is endowed with a duality  $*$ . Then  $\mathcal{C}$  is called a  $\mathbb{Z}$ -graded cellular category if there exists a poset  $\Lambda$  and for each  $\lambda \in \Lambda$  and each object  $n$  in  $\mathcal{C}$  a finite set  $\text{Tab}(n, \lambda)$  which is decomposed as  $\text{Tab}(n, \lambda) = \cup_{i \in \mathbb{Z}} \text{Tab}(n, \lambda)_i$  together with a map  $\text{Tab}(m, \lambda) \times \text{Tab}(n, \lambda) \rightarrow \text{Hom}_{\mathcal{C}}(m, n)$ ,  $(S, T) \mapsto C_{ST}^\lambda$ , satisfying  $C_{ST}^\lambda \in \text{Hom}_{\mathcal{C}}(m, n)_{i+j}$  if  $S \in \text{Tab}(n, \lambda)_i$  and  $T \in \text{Tab}(n, \lambda)_j$ . These data satisfy that  $(C_{ST}^\lambda)^* = C_{TS}^\lambda$  and that

$$\{C_{ST}^\lambda \mid S \in \text{Tab}(m, \lambda), T \in \text{Tab}(n, \lambda), \lambda \in \Lambda\} \text{ is a homogeneous } \mathbb{k}\text{-basis for } \text{Hom}_{\mathcal{C}}(m, n) \quad (2.146)$$

and for all  $a \in \text{Hom}_{\mathcal{C}}(n, p)_i, S \in \text{Tab}(m, \lambda)_j, T \in \text{Tab}(n, \lambda)_k$

$$a C_{ST}^\lambda = \sum_{S' \in \text{Tab}(p, \lambda)_{i+j}} r_a(S', S) C_{S'T}^\lambda \text{ mod } A_{i+j+k}^\lambda \quad (2.147)$$

where  $A^\lambda$  is the span of  $\{C_{ST}^\mu \mid \mu < \lambda, S \in \text{Tab}(m, \mu), T \in \text{Tab}(p, \mu)\}$ .

This following simple fact was already mentioned in [44], in the ungraded case. Let  $\mathcal{C}$  be a graded cellular category and let  $A$  be a finite subset of the objects of  $\mathcal{C}$ . Define  $\text{End}_{\mathcal{C}}(A)$  as the direct sum

$$\text{End}_{\mathcal{C}}(A) := \oplus_{m, n \in A} \text{Hom}_{\mathcal{C}}(m, n). \quad (2.148)$$

Then  $\text{End}_{\mathcal{C}}(A)$  has a  $\mathbb{k}$ -algebra structure as follows

$$g \cdot f := \begin{cases} g \circ f & \text{if } f \in \text{Hom}_{\mathcal{C}}(m, n), g \in \text{Hom}_{\mathcal{C}}(n, p) \text{ for some } m, n, p \\ 0 & \text{otherwise} \end{cases} \quad (2.149)$$

and, in view of (2.145) and (2.147), this is a graded  $\mathbb{k}$ -algebra structure. Moreover, we have the following Theorem.

THEOREM 2.6.9. *Let  $\mathcal{C}$  be a graded cellular category and let  $A$  be a finite subset of the objects for  $\mathcal{C}$ . Define for  $\lambda \in \Lambda$  the set  $\text{Tab}(\lambda) := \cup_{n \in A} \text{Tab}(n, \lambda)$ . Let for  $S \in \text{Tab}(\lambda), T \in \text{Tab}(\lambda)$  the element  $C_{ST}^\lambda \in \text{End}_{\mathcal{C}}(A)$  be defined as the inclusion of  $C_{ST}^\lambda \in \text{Hom}_{\mathcal{C}}(m, n)$  in  $\text{End}_{\mathcal{C}}(A)$ . Then these data define a graded cellular algebra structure on  $\text{End}_{\mathcal{C}}(A)$ .*

*Proof:* Just as in the ungraded case considered in [44], this follows immediately from the definitions.  $\square$

For a general Coxeter system  $(W, S)$ , it was shown in [11] that the diagrammatic Soergel categories  $\mathcal{D}_{(W,S)}$  and  $\mathcal{D}_{(W,S)}^{\mathbb{C}}$ , see Definition 1.4.2 and Remark 1.4.3, are graded cellular categories in the sense of Definition 2.6.8.

Let us indicate the ingredients that make the categories  $\mathcal{D}_{(W,S)}$  and  $\mathcal{D}_{(W,S)}^{\mathbb{C}}$ , see Definition 1.4.2 and Remark 1.4.3, fit into Definition 2.6.8, for our choice of  $(W, S)$ . In case of  $\mathcal{D}_{(W,S)}$ , we use for  $\mathbb{k}$  the ring  $R$ , and for the objects and morphisms we use the objects and morphisms given in Definition 1.4.2. For the poset  $\Lambda$  we use  $W$  itself, endowed with the Bruhat order poset structure. For  $\underline{w} \in \mathbf{exp}$  starting with  $s$  and in reduced form, that is  $\underline{w} = w$ , we use for  $\text{Tab}(\underline{w}, \nu)$  the set of birdcages  $\text{Tab}_w(\nu)$ . For  $\underline{w} \in \mathbf{exp}$  starting with  $t$  and in reduced form, we use for  $\text{Tab}_w(\nu)$  the corresponding set of birdcages  $\text{Tab}_w(\nu)$ . For  $\underline{w} \in \mathbf{exp}$  a general object in  $\mathcal{D}_{(W,S)}$  not in reduced form, we use the general light leaves construction from [11]. Since we do not need the details of this construction we skip it at this point. In case of  $\mathcal{D}_{(W,S)}^{\mathbb{C}}$  we use the same ingredients as for  $\mathcal{D}_{(W,S)}$ , except that for  $\mathbb{k}$  we replace  $R$  by  $\mathbb{C}$ .

Let us now fix a finite subset  $W_0 \subseteq W$  of  $W$  such that  $\nu \in W_0, u \leq \nu \implies u \in W_0$ , that is  $W_0$  is an ideal in  $W$ . For each  $z \in W_0$  we let  $\underline{z}$  be its (unique) reduced expression. We then set  $\underline{W}_0 := \{\underline{z} \mid z \in W_0\} \subseteq \mathbf{exp}$  and define

$$\tilde{A}_{W_0}^{gr} := \text{End}_{\mathcal{D}_{(W,S)}}(W_0) \quad \text{and} \quad \tilde{A}_{W_0}^{gr, \mathbb{C}} := \text{End}_{\mathcal{D}_{(W,S)}^{\mathbb{C}}}(W_0). \quad (2.150)$$

Note that in this setup we recover the graded cellular algebras  $\tilde{A}_w^{gr}$  and  $\tilde{A}_w^{gr, \mathbb{C}}$  by taking  $W_0 := \{w\}$ .

We now have the following Theorem, which is our main reason for changing to the categorical setting.

**THEOREM 2.6.10.**  *$\tilde{A}_{W_0}^{gr, \mathbb{C}}$  is a graded quasi-hereditary algebra over  $\mathbb{C}$ .*

*Proof:* The proof of Theorem 8.5 in [44], corresponding to the ungraded setting, carries over to the present graded setting.  $\square$

Let  $\Delta_{W_0}^{gr}(\nu)$  and  $\Delta_{W_0}^{gr, \mathbb{C}}(\nu)$  be the graded cell modules for  $\tilde{A}_{W_0}^{gr}$  and  $\tilde{A}_{W_0}^{gr, \mathbb{C}}$ . There is an  $R$ -module decomposition

$$\Delta_{W_0}^{gr}(\nu) = \bigoplus_{\underline{z} \in \underline{W}_0} \Delta_{\underline{z}}^{gr}(\nu) \quad (2.151)$$

where we use  $z$  instead of  $w$  to indicate that  $\underline{z}$  may begin with  $s$  as well as  $t$ . There is a similar decomposition for  $\Delta_{W_0}^{gr, \mathbb{C}}(\nu)$ . Let  $\langle \cdot, \cdot \rangle_{\nu}^{W_0}$  be the bilinear form on  $\Delta_{W_0}^{gr}(\nu)$ . It is orthogonal with respect to the decomposition in (2.151). Mimicking what we did for  $\Delta_w^{gr}(\nu)$  we choose  $\alpha$  a root for  $W$  and define for  $\Delta_{W_0}^{gr, \alpha}(\nu)$  via

$$\Delta_{W_0}^{gr, \alpha}(\nu) := \{a \in \Delta_{W_0}^{gr}(\nu) \mid \alpha \text{ divides } \langle a, b \rangle_{\nu}^{W_0} \text{ for all } b \in \Delta_{W_0}^{gr}(\nu)\} \quad (2.152)$$

and set

$$\Delta_{W_0}^{gr, \alpha, \mathbb{C}}(\nu) := \pi(\Delta_{W_0}^{gr, \alpha}(\nu)) \quad (2.153)$$

where  $\pi$  is before. Following [44], we define for  $z \in W_0$  projection maps  $\varphi_z$  as follows

$$\varphi_z : \langle \tilde{A}_{W_0}^{gr, \mathbb{C}} - \text{mod} \rangle_q \rightarrow \langle \tilde{A}_z^{gr, \mathbb{C}} - \text{mod} \rangle_q, \quad \langle \Delta_{W_0}^{gr, \mathbb{C}}(\nu) \rangle_q \rightarrow \langle \Delta_z^{gr, \mathbb{C}}(\nu) \rangle_q \quad (2.154)$$

and arguing as in [44], we get the following compatibility at Grothendieck group level

$$\varphi_z(\langle \Delta_{W_0}^{gr, \alpha, \mathbb{C}}(\nu) \rangle_q) = \langle \Delta_z^{gr, \alpha, \mathbb{C}}(\nu) \rangle_q. \quad (2.155)$$

We have natural homomorphisms of  $\mathbb{Z}[q, q^{-1}]$ -modules

$$\begin{aligned} \text{rk}_{W_0, q} : \langle \tilde{A}_{W_0}^{gr, \mathbb{C}} - \text{mod} \rangle_q &\rightarrow \mathbb{Z}[q, q^{-1}], \quad \langle M \rangle_q \mapsto \text{rk}_q M \\ \text{rk}_{z, q} : \langle \tilde{A}_z^{gr, \mathbb{C}} - \text{mod} \rangle_q &\rightarrow \mathbb{Z}[q, q^{-1}], \quad \langle M \rangle_q \mapsto \text{rk}_q M. \end{aligned} \quad (2.156)$$

Let  $\Phi : \langle \tilde{A}_{W_0}^{gr, \mathbb{C}} - \text{mod} \rangle_q \rightarrow \bigoplus_{\underline{z} \in \underline{W}_0} \mathbb{Z}[q, q^{-1}]$  be the  $\mathbb{Z}[q, q^{-1}]$ -homomorphism whose  $\underline{z}$ 'th coordinate is equal to the composite map  $\text{rk}_{z, q} \circ \varphi_z$ . With this notation we have the following Theorem.

**THEOREM 2.6.11.**  *$\Phi : \langle \tilde{A}_{W_0}^{gr, \mathbb{C}} - \text{mod} \rangle_q \rightarrow \bigoplus_{\underline{z} \in \underline{W}_0} \mathbb{Z}[q, q^{-1}]$  is an isomorphism of  $\mathbb{Z}[q, q^{-1}]$ -modules.*



*Proof:* Since  $\langle \tilde{A}_{W_0}^{gr,C} - \text{mod} \rangle_q$  and  $\oplus_{\underline{z} \in W_0} \mathbb{Z}[q, q^{-1}]$  are free  $\mathbb{Z}[q, q^{-1}]$ -modules of the same rank, it is enough to show that  $\Phi$  is surjective, by Vasconcelos' Theorem once again, see [48]. Let  $f = \sum_{\underline{z} \in W_0} f_{\underline{z}} \in \oplus_{\underline{z} \in W_0} \mathbb{Z}[q, q^{-1}]$  and choose  $f_{\underline{z}_0}$  nonzero and  $\underline{z}_0$  minimal with respect to this condition. The  $\underline{z}_0$ 'th component of  $\Phi(\langle \Delta_{W_0}^{gr,C}(z_0) \rangle_q)$  is  $\text{rk}_{z_0, q}(\Delta_{z_0}(z_0)) = 1$  and so the  $\underline{z}_0$ 'th component of  $\Phi(f_{\underline{z}_0} \langle \Delta_{W_0}^{gr,C}(z_0) \rangle_q)$  is  $f_{\underline{z}_0}$ . On the other hand, the  $\underline{z}$ 'th component of  $\Phi(\Delta_{W_0}^{gr,C}(z_0))$  is  $\text{rk}_{z, q} \langle \Delta_z(z_0) \rangle_q$  which is nonzero only if  $z_0 \leq z$ . Hence, we can use induction on  $f - \Phi(f_{\underline{z}_0} \langle \Delta_{W_0}^{gr,C}(z_0) \rangle_q)$  and get that  $f \in \text{im} \Phi$ , as claimed.  $\square$

We can now prove the promised Grothendieck group extension of Corollary 2.6.6.

COROLLARY 2.6.12. *For  $v \in W_0$  we have  $\Delta_{W_0}^{gr, \alpha, C}(v) = 0$  unless  $w \geq s_\alpha v > v$ . If  $w \geq s_\alpha v > v$  then*

$$\langle \Delta_{W_0}^{gr, \alpha, C}(v) \rangle_q = \langle \Delta_{W_0}^{gr, C}(s_\alpha v)[l(s_\alpha v) - l(v)] \rangle_q. \quad (2.157)$$

*Proof:* We apply  $\Phi$  to (2.157) and check that both sides are equal. Using (2.155) and Corollary 2.6.6 we get that the  $\underline{z}$ 'th component of the left hand side is  $\text{rk}_q \Delta_z^{gr, C}(s_\alpha v)[l(s_\alpha v) - l(v)]$  which by definition of  $\Phi$  coincides with the right hand side. We then use Theorem 2.6.11 to conclude the proof.  $\square$

Finally, the Grothendieck group extension of Corollary 2.6.7 is proved with the same techniques, upon changing the ground ring for the category  $\mathcal{D}_{(W, S)}$  from  $R$  to  $R_1$ . The cell modules for  $\mathcal{D}_{(W, S)}$  are called  $\Delta_{W_0}^{gr, \mathbf{x}}(v)$  and we define for  $k = 1, 2, \dots$

$$\Delta_{W_0}^{gr, k, \mathbf{x}}(v) := \{a \in \Delta_{W_0}^{gr, \mathbf{x}}(v) \mid \langle a, b \rangle_v^{W_0} \in \mathbf{x}^k R_1 \text{ for all } b \in \Delta_{W_0}^{gr, \mathbf{x}}(v)\} \quad (2.158)$$

and set

$$\Delta_{W_0}^{gr, k, C}(v) := \pi(\Delta_{W_0}^{gr, k, \mathbf{x}}(v)). \quad (2.159)$$

Mimicking the proof of Corollary 2.6.12 we then have the following generalization of Corollary 2.6.7.

COROLLARY 2.6.13. *The following graded analogue of Jantzen's sum formula holds:*

$$\sum_{k > 0} \langle \Delta_{W_0}^{gr, k, C}(v) \rangle_q = \sum_{\substack{\alpha > 0 \\ v < s_\alpha v \leq w}} \langle \Delta_{W_0}^{gr, C}(s_\alpha v)[l(s_\alpha v) - l(v)] \rangle_q. \quad (2.160)$$

## Bibliography

- [1] H. H. Andersen, *A sum formula for tilting filtrations*, Journal of Pure and Applied Algebra **152** (2000), 17-40.
- [2] H. H. Andersen, *Filtrations of cohomology modules for Chevalley groups*, Annales scientifiques de l'É.N.S. 4<sup>e</sup> série, tome **16**, n<sup>o</sup> 4 (1983), 495-528.
- [3] H. H. Andersen, J. C. Jantzen, W. Soergel, *Representations of quantum groups at a  $p$ -th root of unity and of semisimple groups in characteristic  $p$ : independence of  $p$* , Astérisque **220** (1994) Paris: Société Mathématique de France, p. 321.
- [4] A. Beilinson, V. Ginzburg, W. Soergel, *Koszul duality patterns in representation theory*, J. Am. Math. Soc. **9**(2) (1996), 473-527.
- [5] C. Bowman, A. Cox, A. Hazi, *Path isomorphisms between quiver Hecke and diagrammatic Bott-Samelson endomorphism algebras*, arXiv:2005.02825, to appear in Advances in Mathematics.
- [6] C. Bowman, A. Cox, A. Hazi, D. Michailidis, *Path combinatorics and light leaves for quiver Hecke algebras*. Math. Z. **300**(3) (2022), 2167-2203.
- [7] J. Brundan, A. Kleshchev, *Blocks of cyclotomic Hecke algebras and Khovanov-Lauda algebras*, Invent. Math. **178** (2009), 451-484.
- [8] G. Burrull, N. Libedinsky, P. Sentinelli,  *$p$ -Jones-Wenzl idempotents*, Advances in Mathematics **352** (2019), 246-264.
- [9] A. Cox, J. Graham, P. Martin, *The blob algebra in positive characteristic*, Journal of Algebra, **266**(2) (2003), 584-635.
- [10] B. Elias, N. Libedinsky, *Indecomposable Soergel bimodules for universal Coxeter groups. With an appendix by Ben Webster*, Trans. Am. Math. Soc. **369**(6) (2017), 3883-3910.
- [11] B. Elias, G. Williamson, *Soergel calculus*, Representation Theory **20** (2016), 295-374.
- [12] M. Ehrig, C. Stroppel, *Koszul gradings on Brauer algebras*, Int. Math. Res. Not. **2016** (13) (2016), 3970-4011.
- [13] P. Fiebig, M. Lanini, *The combinatorial category of Andersen, Jantzen and Soergel and filtered moment graph sheaves*, Abh. Math. Semin. Univ. Hamb. **86**(2) (2016), 203-212.
- [14] A. M. Gainutdinov, J. L. Jacobsen, H. Saleur, R. Vasseur, *A physical approach to the classification of indecomposable Virasoro representations from the blob algebra*, Nuclear Physics B, **873**(3) 2013, 614-681.
- [15] J. J. Graham, G. I. Lehrer, *Cellular algebras*, Inventiones Mathematicae **123** (1996), 1-34.
- [16] J. J. Graham, G. I. Lehrer, *The representation theory of affine Temperley-Lieb algebras*, Enseign. Math., II. Sér. **44**(3-4) (1998), 173-218.
- [17] A. Hazi, P. Martin, A. Parker, *Indecomposable tilting modules for the blob algebra*, Journal of Algebra **568** (2021), 273-313.
- [18] M. Hogancamp, D. E. V. Rose, P. Wedrich, *A Kirby color for Khovanov homology*, arXiv:2210.05640, to appear in Journal of the European Mathematical Society.
- [19] J. Hu, *BGG Category  $\mathcal{O}$  and  $\mathbb{Z}$ -Graded Representation Theory*, in: East China Normal University Scientific Reports **16**, Forty Years of Algebraic Groups, Algebraic Geometry, and Representation Theory in China.
- [20] J. Hu, A. Mathas, *Graded cellular bases for the cyclotomic Khovanov-Lauda-Rouquier algebras of type A*, Adv. Math., **225** (2010), 598-642.
- [21] J. E. Humphreys, *Reflection groups and Coxeter groups*, volume **29** of Cambridge Studies in Advanced Mathematics. Cambridge University Press, Cambridge, 1990.
- [22] J. Humphreys, *Representations of semisimple Lie algebras in the BGG category  $\mathcal{O}$* , (2008), Graduate Studies in Mathematics 94, Providence, R.I.: American Mathematical Society, ISBN 978-0-8218-4678-0.
- [23] Iohara, K., Koga, Y. *Representation Theory of the Virasoro Algebra*, Springer Monographs in Mathematics. Springer, London (2011).
- [24] J. C. Jantzen, *Moduln mit einem höchsten Gewicht*, Lect. Notes in Math. **750** Springer-Verlag, 1979.
- [25] V. F. R. Jones, *Index for subfactors*, Invent. Math. **72**(1) (1983) 1-25.
- [26] L. H. Kauffman, *State models and the Jones polynomial*, Topology **26** (1987), no. 3, 395-407.
- [27] L. H. Kauffman, *Statistical mechanics and the Jones polynomial*, Braids (Santa Cruz, CA, 1986), Contemp. Math., vol. 78, Amer. Math. Soc., Providence, RI, 1988, pp. 263-297.
- [28] M. Khovanov, A. Lauda, *A diagrammatic approach to categorification of quantum groups I*, Represent. Theory **13** (2009), 309-347.
- [29] N. Libedinsky, *Gentle introduction to Soergel bimodules I: The basics*, Sao Paulo Journal of Mathematical Sciences, **13**(2) (2019), 499-538.
- [30] N. Libedinsky, *Sur la catégorie des bimodules de Soergel*, Journal of Algebra **320** (2008) 2675-2694.
- [31] N. Libedinsky, *Light leaves and Lusztig's conjecture*. Adv. Math. **280**, 772-807 (2015).
- [32] N. Libedinsky, D. Plaza, *Blob algebra approach to modular representation theory*. Proc. Lond. Math. Soc. (3) **121**, No. 3, 656-701 (2020).
- [33] D. Lobos, D. Plaza, S. Ryom-Hansen, *The nil-blob algebra: an incarnation of type  $\tilde{A}_1$  Soergel calculus and of the truncated blob algebra*, Journal Algebra **570** (2021), 297-365.
- [34] D. Lobos, S. Ryom-Hansen, *Graded cellular basis and Jucys-Murphy elements for generalized blob algebras*, Journal of Pure and Applied Algebra, **224**(7) (2020), 106277, 1-40.
- [35] P. P. Martin, H. Saleur, *The blob algebra and the periodic Temperley-Lieb algebra*, Lett. Math. Phys. **30** (1994), 189-206.
- [36] P. P. Martin, D. Woodcock, *On the structure of the blob algebra*, J. Algebra **225**(2) (2000), 957-988.
- [37] A. Mathas, *Positive Jantzen sum formulas for cyclotomic Hecke algebras*, Math. Z. **301**(3) (2022), 2617-2658.
- [38] D. Michailidis, *Bases and BGG resolutions of simple modules of Temperley-Lieb algebras of type B*, Int. Math. Res. Not. **2022**(12) (2022), 9357-9412.
- [39] D. Plaza, *Graded decomposition numbers for the blob algebra*, J. Algebra **394**, (2013), 182-206.

- [40] D. Plaza, *Graded cellularity and the monotonicity conjecture*, Journal Algebra **473** (2017), 324-351.
- [41] D. Plaza, S. Ryom-Hansen, *Graded cellular bases for Temperley-Lieb algebras of type A and B*, Journal of Algebraic Combinatorics, **40**(1) (2014), 137-177.
- [42] H. Russell, *The Bar-Natan skein module of the solid torus and the homology of  $(n, n)$  Springer varieties*, Geom. Dedicata **142** (2009), 71-89.
- [43] J. Scott Carter, Daniel E. Flath, and Masahico Saito. *The classical and quantum 6j-symbols*, volume 43 of Mathematical Notes. Princeton University Press, Princeton, NJ, 1995. MR1366832.
- [44] S. Ryom-Hansen, *Jucys-Murphy elements for Soergel bimodules*, Journal of Algebra, **551** (2020), 154-190.
- [45] P. Shan, *Graded decomposition matrices of  $v$ -Schur algebras via Jantzen filtration*, Represent. Theory **16** (2012), 212-269.
- [46] C. Stroppel, *Category  $\mathcal{O}$ : gradings and translation functors*, J. Algebra **268** (1) (2003), 301-326.
- [47] G. Williamson, *Schubert calculus and torsion*, arXiv:1309.5055.
- [48] W. V. Vasconcelos, *On finitely generated flat modules*, Trans. Amer. Math. Soc., **138** (1969), 505-512.
- [49] H. Wenzl, *On sequences of projections*, C. R. Math. Rep. Acad. Sci. Can. **9** **1** (1987), 5-9.
- [50] B. W. Westbury, *Invariant tensors and cellular categories*, Journal of Algebra, **321**(11) 2009, 3563-3567.